

MGM BAILEY INTERNATIONAL

WINDOWS & DOORS
ALUMINIUM BALUSTRADES
STAINLESS STEEL FITTINGS & STRUCTURES



Find us on
Facebook

buildBITS
"Your Savings are Building"



Email - nathan@mgmbs.com

Or

Mobile - 0466 896 292

38 Waterview Street, Carlton NSW 2218

80mm Sliding Door

Available
Now!

- 1.Design economically for strength aesthetics and performance
- 2.AU80 Door has been designed with simplicity for both the manufacture and installer.
- 3.The wind pressure capacity AU80 sliding double door can reach and exceed 600PA and has passed 300 pascal of water pressure.
- 4.Using double installed IGU's allows the door to have high thermal application and Sound insulation is also much higher than standard doors due to the cavity aluminum design and double glazing.
- 5.High track design utilizing mohair seals assist the resistance of water penetration.
- 6.Simple and vivid sections, good lighting ability and stylish mullion design.
- 7.Designed for looks and strength keep the price affordable.
- 8.Many configurations are available, 6 panels, 4 panels, 3 panels, 2 panels.

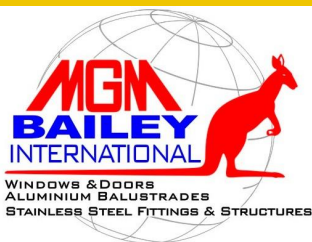

80mm Sliding Door Type

Two panel door



DRAWING/NO. 8000-001
8000 sliding door layout

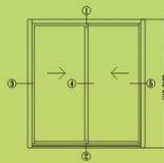

ALL GLASS TO BE AS PER AUSTRALIAN
STANDARD AS1288-2009

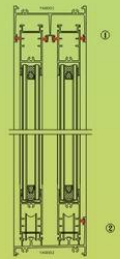

SECTION

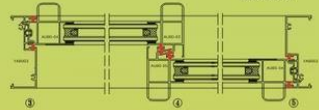

PLAN

Three panel door



DRAWING/NO. 8000-002
8000 sliding door layout

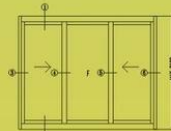

ALL GLASS TO BE AS PER AUSTRALIAN
STANDARD AS1288-2009

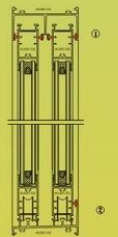

SECTION

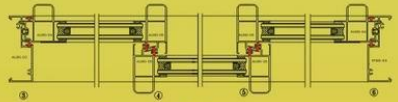

PLAN

Four panel door



DRAWING/NO. 8000-003
8000 sliding door layout

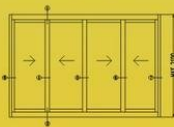

ALL GLASS TO BE AS PER AUSTRALIAN
STANDARD AS1288-2009



SECTION



PLAN

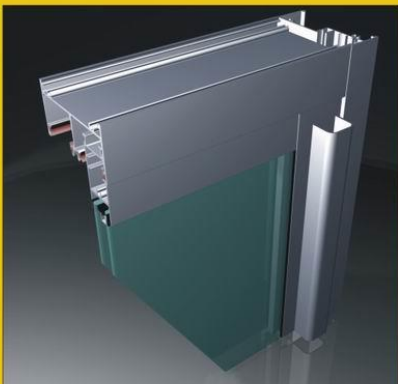

Sliding Door Section

Sliding door head

Part NO. :

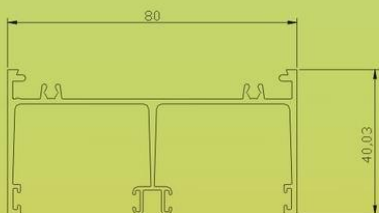

Sliding door jamb section

Part NO. :

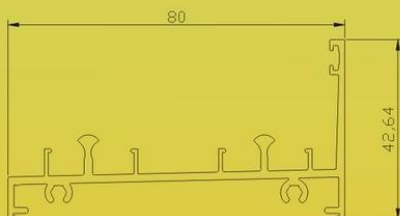

Sliding door jamb section

Part NO. :

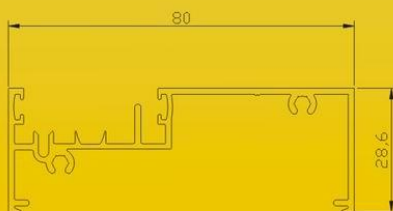

Sliding door lock stile/ fixed stile

Part NO. :

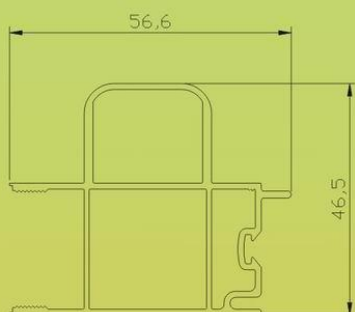

Sliding door H/D mating stile

Part NO. :

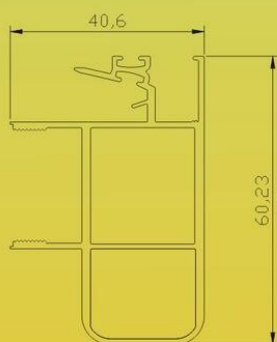

Sliding door rail

Part NO. :

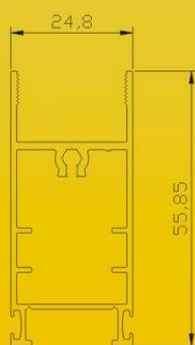

Sliding Door Accessories



Roller

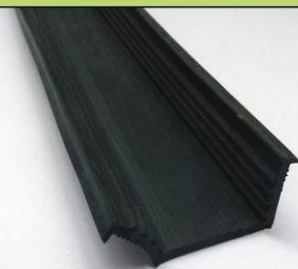

Rubber



Lock



Rubber

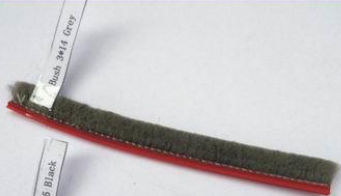

Mohair



Mohair



Screw



Double glazed
IGU glass

Contact Nathan about your project requirements -

Email - nathan@mgmbs.com

Or

Mobile - 0466 896 292

38 Waterview Street, Carlton NSW 2218

80mm Sliding Window

Available
Now!

- 1.Design economically for strength aesthetics and performance
- 2.AU80 window has been designed with simplicity for both the manufacture and installer.
- 3.The wind pressure capacity AU80 sliding window can reach and exceed 600A and has passed 300 pascal of water pressure.
- 4.Using double installed IGU's allows the window to have good thermal application and Sound insulation.
- 5.High track design utilizing mohair seals assist the resistance of water penetration.
- 6.Simple sections makes a good and simple window.
- 7.Designed for looks and strength keeping the price affordable.
- 8.Many configurations are available, 4 panels, 3 panels, 2 panels.



80mm Sliding Window Type

Two panel window



DRAWING/NO. 8000-001
8000 sliding window layout

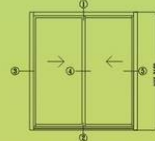

ALL GLASS TO BE AS PER AUSTRALIAN
STANDARD AS1288-2009



SECTION

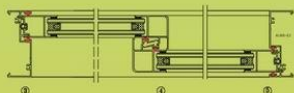

PLAN

Three panel window



DRAWING/NO. 8000-002
8000 sliding window layout

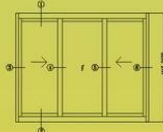

ALL GLASS TO BE AS PER AUSTRALIAN
STANDARD AS1288-2009

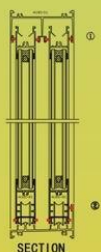

SECTION

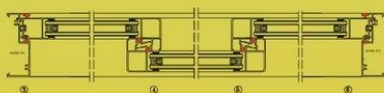

PLAN

Four panel window



DRAWING/NO. 8000-003
8000 sliding window layout

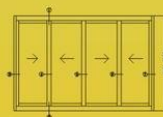

ALL GLASS TO BE AS PER AUSTRALIAN
STANDARD AS1288-2009

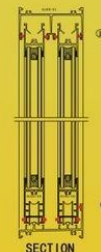

SECTION

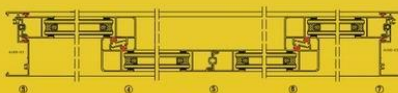

PLAN



Sliding window Section

Sliding window

Part NO. :

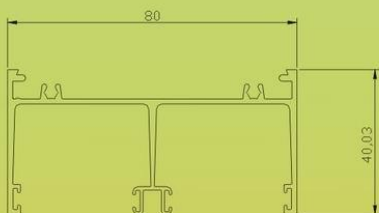

Sliding window jamb section

Part NO. :

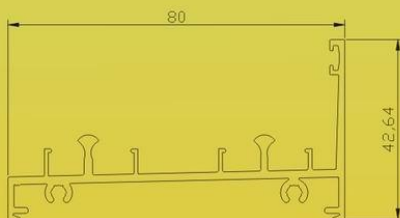

Sliding window jamb

Part NO. :

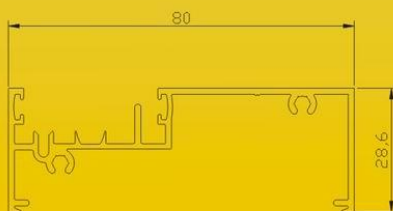

Sliding window lock stile/fixe

Part NO.:

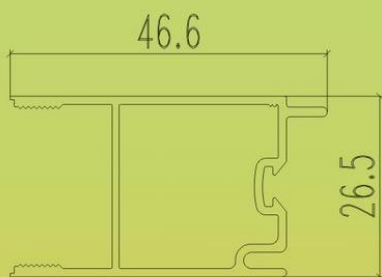

Sliding window H/D mating stile

Part NO.:

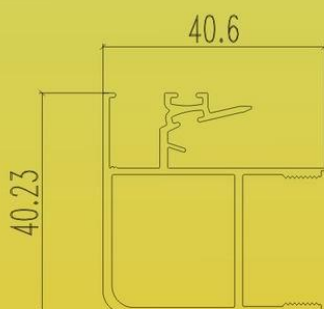

Sliding window rail

Part NO.:

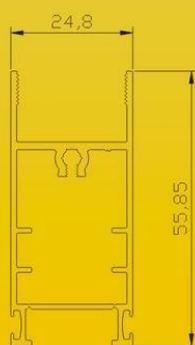

Sliding window Accessories



Roller

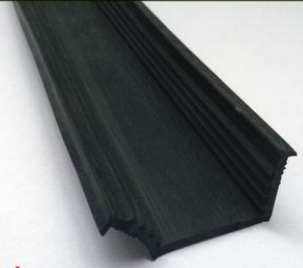

Rubber



Double glazed
IGU glass



Rubber



Mohair



Mohair



Screw

Contact Nathan about your project requirements -

Email - nathan@mgmbs.com

Or

Mobile - 0466 896 292

38 Waterview Street, Carlton NSW 2218

Awning window system

Available
Now!

- 1.Design economically for strength, aesthetics and performance
- 2.AU80Awning has been designed As a flush awning system so that installation is far easier than the traditional face fixed awning window.
- 3.The wind pressure capacity AU80 Awning window can reach and exceed 900 PA and as high as 450 pa water rating.
- 4.Using double installed IGU's allows the Awing window to have high thermal protection and better than everage sound insulation.
- 5.Many configurations are available, limited by your imagination.



Awning window Type

One panel window



DRAWING/NO. AW80-001
80mm Frame Awning Window layout



ISOMETRIC VIEW AT 45° OF



Two panel window



DRAWING/NO. AW80-002
80mm Frame Awning Window layout

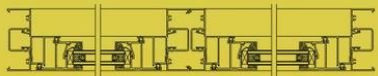
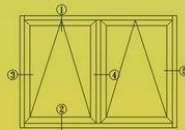

Two panel window and fixed window



DRAWING/NO. AW80-003
80mm Frame Awning Window layout



Awning Window Section

Sliding door lock stile/fixed stile

Part NO.:

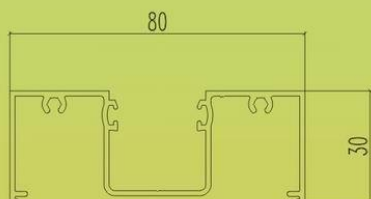

Sliding door lock stile/fixed stile

Part NO.:

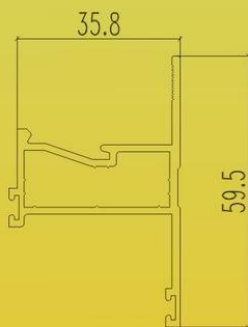

Sliding door lock stile/fixed stile

Part NO.:

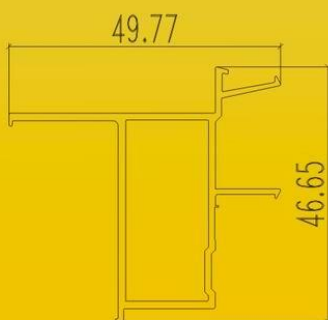

Awning window Accessories

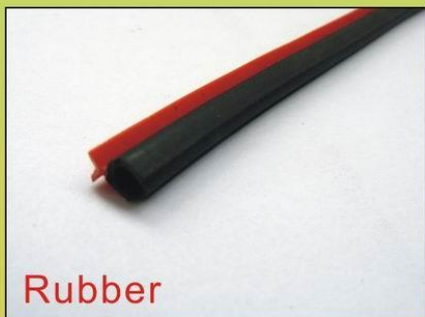
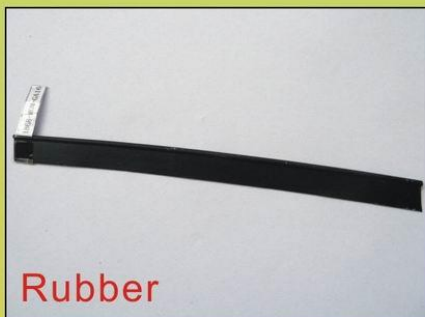

Contact Nathan about your project requirements -

Email - nathan@mgmbs.com

Or

Mobile - 0466 896 292

38 Waterview Street, Carlton NSW 2218

FIXED | **SLIDING** | **AWNING** | **COMBINATION** | **CURTAIN WALLS**



**Aluminium & Stainless Steel Glass Balustrade - Frameless
Glass Pool Fencing - Glass Blocks - Glass Shelves - Mirrors -
Glass cut to size - Magnetic Glass Boards - Aluminium
Louvres - Circuit Breakers - Split System Air Conditioners**

**For all your project requirements contact
- nathan@mgmbs.com or 0466 896 292**

RESIDENTIAL | **COMMERCIAL** | **SUPPLY ONLY** | **SUPPLY & INSTALL**