

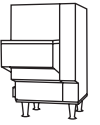

The Future of Frying....Today!



Perfect Fryer

Automated bench top fryer



FOOD EQUIPMENT SOLUTIONS



A PROVEN WINNER

Fried food generates large profits for your business from direct sales and from its ability to draw additional customers to your business. In the past the problem with introducing fried food into your business has been a high level of cost, resources, risk and retail space - but not anymore.

Perfect Fry Company now offers a solution that gives you all the profits associated with fried food without any of the hassles.

TO FRY OR NOT TO FRY - NEW ALTERNATIVES TO FRYING

Frying is still the most efficient process available today to provide fast cooked food with a crisp outer maintaining freshness and moisture inside and having a long shelf life. Whether it's oven cooked, grilled, microwaved or varying combinations; nothing comes close to achieving the same results as frying. Customers know the difference.

PROFITABLE

Gross margins of up to 70% and more are easily achievable for most business types. If you can sell \$200 worth of hot food a day then you can make a profit of more than \$50,000 in a year.

SALES DAY	PROFIT DAY	PROFIT MONTH	PROFIT YEAR
\$100	\$ 70	\$ 2,129	\$ 25,550
\$200	\$140	\$ 4,258	\$ 51,100
\$400	\$280	\$ 8,517	\$102,200
\$600	\$420	\$12,775	\$153,300
\$800	\$560	\$17,033	\$204,400

* Note figures are for illustration only - they will vary according to types of food, cost prices etc. Please verify figures for yourself

These figures are rough estimates as obviously it depends on business types, locations and where frying fits into your overall menu. We can provide a more industry specific worksheet to help you better calculate estimated sales and profits for your business as well as giving you basic break even analysis for your equipment selection including the operating costs. Once we better understand your business, we can better apply the figures to see how a Perfect Fryer can increase your sales and profits.

Fried food can be as easy or complex as you like. There are literally hundreds of options of food also available that are frozen and ready for frying offering great margins and long shelf life. By building on what is available you can create some unforgettable localised creations. Whether you choose to coat your own chicken, use a special recipe for buffalo wings, utilise the fryer to cook chicken schnitzels and other meats and sausages to make your own sandwiches, rolls and wraps - the fryer will provide you with great versatility. At the same time the Perfect Fryer cuts down on labour costs, preparation requirements and the space and infrastructure normally required.



Perfect Fryer

Automated bench top fryer



FOOD EQUIPMENT SOLUTIONS



WHY CHOOSE THE PERFECT FRYER?

EASY TO INSTALL

As a self contained unit, the Perfect Fryer has no external hoods, canopies or venting which means installation costs are kept to a minimum, and as a compact unit there is very little retail space required to accommodate the unit.

NO SMELLS

The units come with a unique air filtration system that removes grease from the air which eliminates the normal odours you get from frying.

EASY TO USE

The Perfect Fryers are automated which means all you have to do is select the appropriate cooking cycle depending on what type of food you are cooking and then press the button. There is no chance of over cooking or under cooking which means non cooks or chefs will be able to cook food to perfection. There is also an easy to follow manual that comes with the units plus access to a 24 hour a day, 7 day a week national helpline.

LARGE OUTPUT

Although compact in size, the fryer can produce a large quantity of food in a short period of time and with 2 different sizes to choose from you can select the one that best meets your requirements.

VARIETY OF FOOD

The Perfect Fryer does not just cook chips - it can cook hundreds of different types of food including dim sims, potato cakes, spring rolls, fish fillets, calamari, chicken peices, wings, nuggets and schnitzels and more.

SAFE

The operator does not come in contact with the hot oil when cooking and the unit comes with a complete fire suppression system and inbuilt extinguishers which means there are none of the normal insurance issues. The fryers surpass all the safety requirements and are OH & S compliant.

EASY TO MAINTAIN

No other fryer is easier to clean. Internal components are completely removable in less than a minute to allow cleaning in your sink or dishwasher. All parts come with a 12 month warranty and next business day delivery policy on replacement parts.

EASY TO FINANCE

We can easily provide you with a range of options for finance that allows the fryer to pay for itself out of profits rather than upfront. Options range to suit your specific requirements.

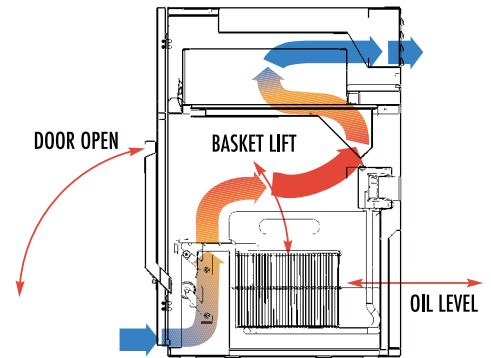

Perfect Fryer

Automated bench top fryer



FOOD EQUIPMENT SOLUTIONS

PFC 5700

The PFC 5700 is a compact unit that is easy to use and maintain - making it ideal for most sites.

It comes with its own inbuilt air filtering device which means there are no smells and you don't need an external venting or exhaust system.

It is a fully enclosed unit which means it is safe for all staff to use.

The automated unit cooks approximately 1kg of product per cycle producing a large output over a short period of time.

The modular design also means it is simple to clean.



HOW IT WORKS

A simple 3 step process whereby you place the food in the basket and put the basket inside the unit. Then select either the pre-set button for the food you're cooking or proceed manually like you would with a microwave. The basket automatically lowers into the oil, cooks and when it's completed lifts and beeps to indicate the process has finished. Frying time is generally 2 to 6 minutes for most products.

STEP 1



STEP 2



STEP 3

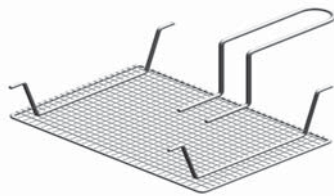

Optional Basket Cover for Extra Large Basket

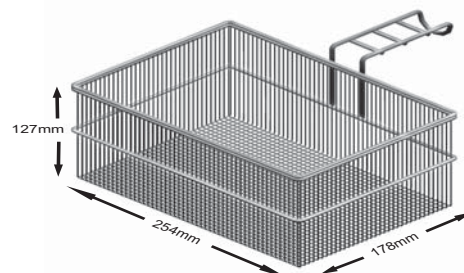

Extra Large basket - comes standard with a unit



Perfect Fryer

Automated bench top fryer



FOOD EQUIPMENT SOLUTIONS

PFA 7200



The PFA 7200 is a more automated unit with greater output than the PFC 5700 and is ideal for larger turn over sites. Also an enclosed unit with no external venting or exhaust system needed, it will still fit neatly into any environment.

The PFA 7200 has an automated delivery system giving it two distinct advantages.

Firstly, there are no baskets which means staff simply drop food into the hopper and press the button. Once the food is cooked, it drops into the tray below – simple.

Secondly, the PFA 7200 cooks continuously and has a fast recovery time; generating large volumes of food in a short period of time.

And like the 5700 model it cooks hot food without the smells and its modular design makes it easy to clean and maintain.



HOW IT WORKS

Simply place food into the hopper on the front of the unit. Then select either the pre-set button for the food you're cooking or enter manually like you would a microwave. The food automatically gets tipped into the oil, cooks and when it's completed is dispensed into the tray on the bench. A great feature of this unit is the ability to reload the draw while something is cooking, when the cooked food is dispensed it will automatically send the next batch into the oil, meaning no downtime and greater output.

STEP 1

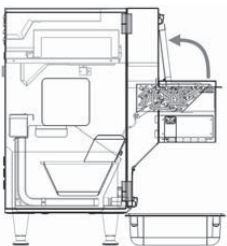

STEP 2

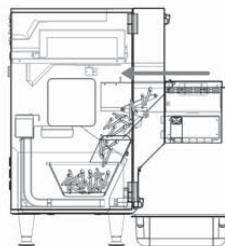

STEP 3

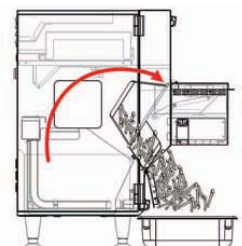

Optional Heat Lamp fits to the front of the PFA Model to keep food warm after dispensing into the tray under the outgoing chute. The ceramic heating plate maintains enough heat in the product to ensure your chips remain hot from the fryer to the customer, even if it takes your staff a few minutes to get them on the plate.



Perfect Fryer

Automated bench top fryer



FOOD EQUIPMENT SOLUTIONS



We were doing a fish and chip offer....but it was a hassle for the kitchen - extended kitchen hours, interruption to meal times and the cost to keep the dedicated staff on and the kitchen open. That was when we discovered the Perfect Fryer. We were able to put the fryer behind the bar, allowing us to offer food all hours.....it meant great cost savings as the existing bar staff were now cooking the food.

Brian Asley (General Manager of Trios Tabaret Cranbourne Racecourse and President of the Knox Club)



We are now achieving 18% of our sales through Chips.....Your chip machine has proved to be our best investment yet and after 4 years of hard work it has never broken down or caused any problems...our chip sales are now above our drinks in percentage and have proven a great profit centre for us, encouraging all other sales at the store.....we estimate that we paid for our machine in the first 4 months.

Terry Sherlock (Jesters, Cannington)



Perfect Fryer

Automated bench top fryer



FOOD EQUIPMENT SOLUTIONS



As a food and coffee retailer with major plans to expand, we were looking for a food equipment supplier that had a proven record. We brought in the Perfect Fry Company as our food equipment supplier a number of years ago and have not looked back. We now have successfully opened 18 outlets - having suppliers like Perfect Fry have certainly contributed to that success.

Wayne Stoll (Coffee HQ)



As we began upgrading our sites, the inclusion of a hot food offer was a big decision. We enlisted the help of Perfect Fry for the first site and by the time we got to work on our second site the success of hot food was unquestionable. The Perfect Fry System has lived up to every promise and has been instrumental in creating the very profitable hot food range in our business. It is straightforward and hardly takes up any space and it now forms a big part of our business.

Darren Nosedo (Nosedo Retail, BP and IGA Express)



Perfect Fryer

Automated bench top fryer



FOOD EQUIPMENT SOLUTIONS

SPECIFICATIONS

Fryer



PERFECT FRY

- Easy to install - no hoods
- No smells
- Easy to use, fully automated
- Safe - fully enclosed
- Large output - range of models
- Easy to clean and maintain
- Easy to finance

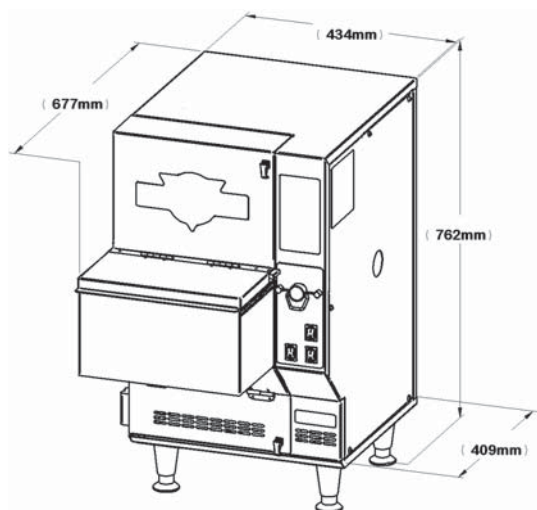

PFA 7200

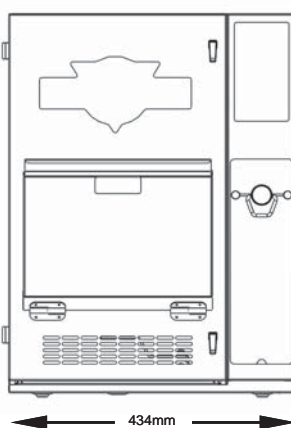

PFC 5700

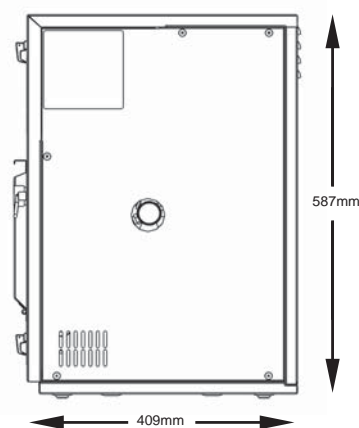

MODEL	DIMENSIONS H x W x D	POWER SUPPLY	PHASE	CURRENT (A)	POWER (KW)	CAPACITY*	OIL VOLUME	WEIGHT
PFA 7200	762X434X677	240v/50Hz	SINGLE	30	7.2	16-22kg	11ltr	57kg
PFC 5700	587x434x409	240v/50Hz	SINGLE	24	5.7	12-18kg	8ltr	36kg

*Capacity varies based on product type and cooking times.

For an installation checklist, please call 1800 265 771



Perfect Fryer
Automated bench top fryer



Ph: **1800 265 771**
PO Box 923, Croydon, VIC, 3136, Australia
www.perfectfry.com.au