



# Vanitone<sup>TM</sup>

A Division of RTM Products Pty Ltd

**TRADITIONALLY CRAFTED  
TIMBER VANITY UNITS**

Proudly Made in Australia

[www.vanitone.com.au](http://www.vanitone.com.au)

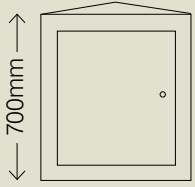
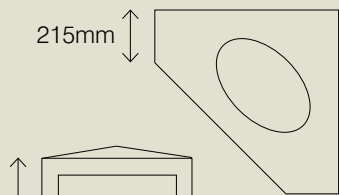

Corner Wall Unit  
370mm x 370mm

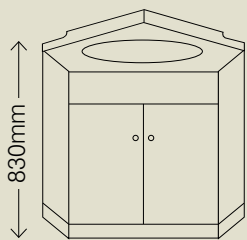

750mm x 750mm Corner

**BLAXLAND**

Shown in Mahogany

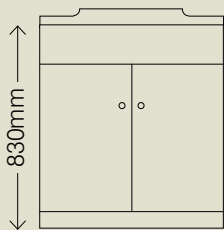

W 750mm x D 500mm

**BLAXLAND**

Shown in Baltic



**Colours**

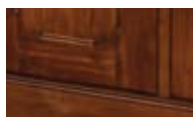

Walnut



Baltic

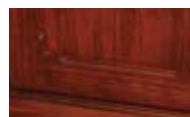

Mahogany

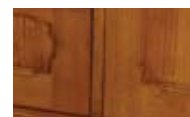

Parramatta Brown



Stressed Baltic

Due to the nature of the printing process, colours are an indication only and may vary slightly from the original product colour



Shown in Walnut

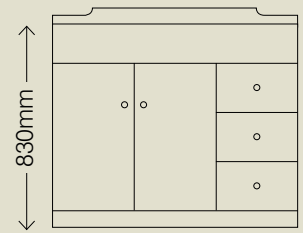

W 1000mm x D 500mm (pictured)

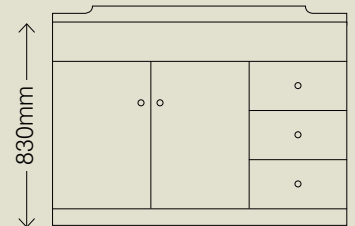

W 1200mm x D 500mm

## BLAXLAND



Shown in Parramatta Brown

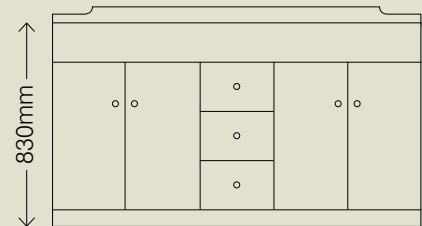

W 1500mm x D 500mm  
Double Bowl (pictured)



W 1500mm x D 500mm  
Single Bowl

## BLAXLAND

### Options



Wall Mirror



Wall Unit (reversible)

### Wall Mirror Sizes

620mm x 665mm

750mm x 665mm

1000mm x 665mm

1500mm x 665mm

### Wall Unit Sizes

750mm x 775mm

1000mm x 775mm

370mm x 370mm Corner

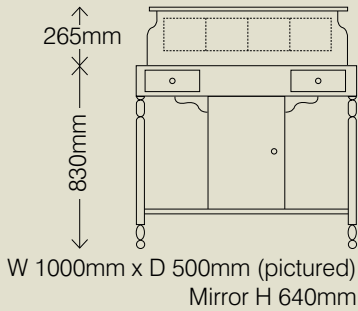
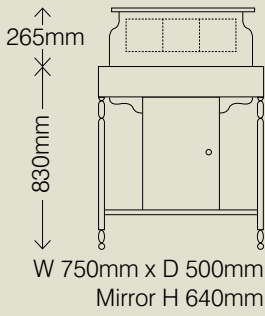

## FEDERATION WASHSTAND



Shown in Walnut with optional mirror • Tiles not supplied

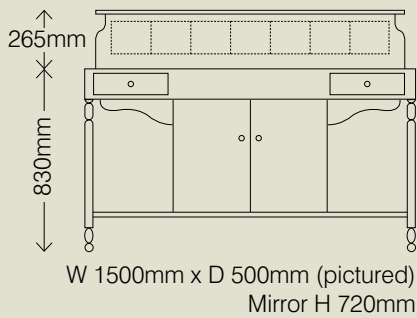
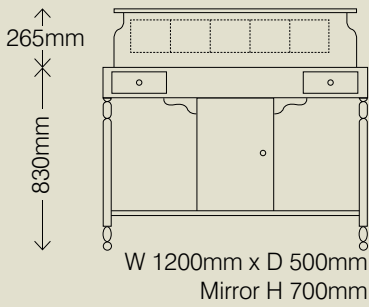

## FEDERATION WASHSTAND



Shown in Parramatta Brown • Tiles not supplied

### Colours

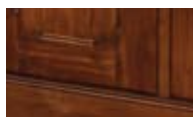

Walnut



Baltic

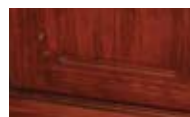

Mahogany

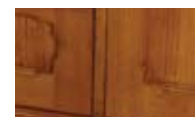

Parramatta Brown



Stressed Baltic

Due to the nature of the printing process, colours are an indication only and may vary slightly from the original product colour



Shown in Stressed Baltic

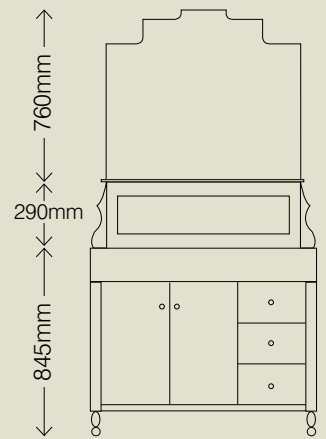

W 1000mm x D 500mm  
Overall H 1895mm  
Includes Mirror as standard

## STRATFORD



Shown in Mahogany

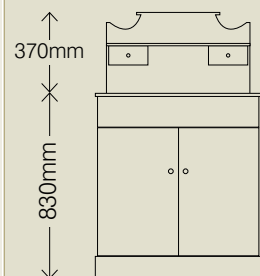

W 750mm x D 500mm

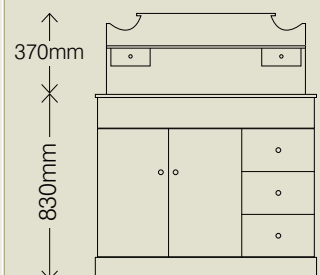

W 1000mm x D 500mm (pictured)

## PADDINGTON

### Options



Washstand Mirror



Wall Mirror (to suit Paddington)



Wall Unit (reversible)

### Wall Mirror Sizes

620mm x 665mm

750mm x 665mm

1000mm x 665mm

### Wall Unit Sizes

750mm x 775mm

1000mm x 775mm

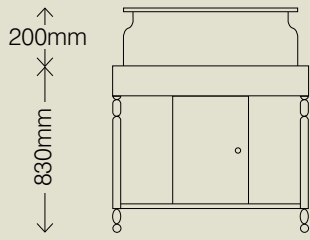

W 900mm x D 500mm

## RENOVATOR WASHSTAND

Shown in Baltic • Use Blaxland Wall Mirror or Wall Unit

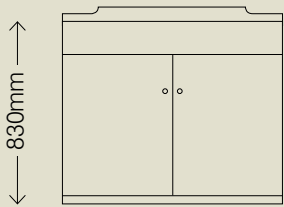

W 1000mm x D 500mm

## RENOVATOR NORWOOD

Shown in Mahogany • Use Blaxland Wall Mirror or Wall Unit

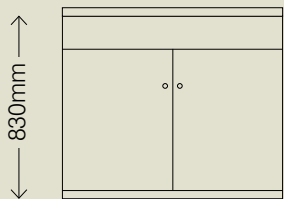

W 1000mm x D 500mm

## RENOVATOR MITCHAM

Shown in Parramatta Brown • Use Blaxland Wall Mirror or Wall Unit



### Colours

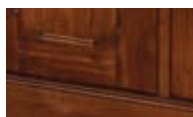

Walnut



Baltic

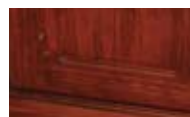

Mahogany

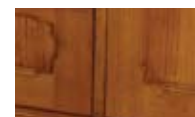

Parramatta Brown

Due to the nature of the printing process, colours are an indication only and may vary slightly from the original product colour

**NEW MODELS**



Shown in Mountain Ash

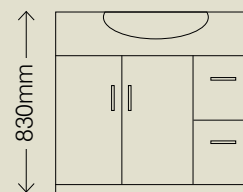

W 900mm x D 340mm

## GRANGE



Shown in Chestnut

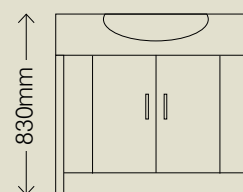

W 900mm x D 340mm

## HENLEY



Shown in Mountain Ash

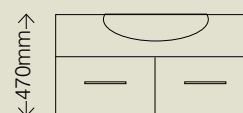

W 900mm x D 340mm

## LINCOLN (Wall Mounted)

### Colours



Chestnut



Mountain Ash

Designed to suit the Caroma Cosmo S/R Basin.

Due to the nature of the printing process, colours are an indication only and may vary slightly from the original product colour

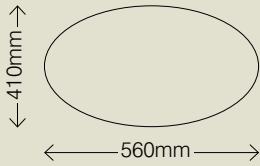

## CLASSIC BASIN



Colours: White (pictured), Ivory & Alabaster • Available with 1, 2 or 3 tap holes • Polymarble  
10 year replacement warranty

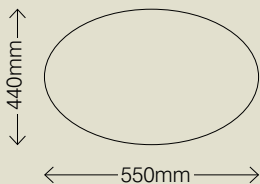

## FEDERATION BASIN



Colours: White, Alabaster & Ivory (pictured) • Available with 1, 2 or 3 tap holes • Polymarble  
10 year replacement warranty

**VANITONE** furniture is moisture and humidity resistant and is treated with a durable two pack lacquer finish.

Our units are manufactured from a combination of solid timbers and selected timber veneers. As such, variations in texture, grain and colour may occur.

Except for 'GRANGE', 'HENLEY' and 'LINCOLN', brass handles are standard on all units but chrome handles are available as an option.

All measurements are approximate.

All units with drawers are supplied with right hand drawers.

Tapware, tiles and 'COSMO' basins are not supplied by **VANITONE**.

Due to the nature of the printing process colours are indicative only.

**RTM PRODUCTS PTY LTD** reserves the right to change specifications without notice.

Copyright of this document and the products and concepts presented in it are strictly reserved to **RTM PRODUCTS PTY LTD**. No unauthorised use or copying is permitted. All rights reserved December 2008.

RTM Products Pty Ltd  
39 Dunorlan Road  
Edwardstown SA 5039

T: 08 8374 0877  
F: 08 8374 0879  
E: sales@vanitone.com.au

[www.vanitone.com.au](http://www.vanitone.com.au)

Available from: