



Concept Latch, Lock & Hinge Catalogue

Ref: 005



We stock these brands, and much more:

EBERHARD

southco

Rencol
COMPONENTS

Rohde

ROLLON

Accuride

PIVOTPOINT
INC.

STABILUS

SUGATSUNE

INTRODUCTION

Concept Latch Lock and Hinge was founded in 1989, supplying industrial components and hardware to a wide variety of customers and industries.

We represent internationally renowned companies, whereby quality, delivery and engineering experience make us a leader amongst our competitors, offering over 25,000 products to the market.

Our range of products are from high quality international manufacturers with many well-known brands, including Accuride, Rollon, Southco, Stabilus, Eberhard, Rencol, Pivot Point, Frigerio, Sugatsune, and many others.

We aim for our products to provide low installation costs and ease of assembly, reducing the total manufacturing costs for our customers.

THIS CATALOGUE

The purpose of this catalogue is to provide an overview or snapshot of many of the product lines available in the Concept Latch Lock & Hinge range.

For full product details, drawings, further information or other options on any of the items you may be interested in, please visit our website at www.conceptlatch.com.au. Alternatively you can email or call our office on 03 9388 2551 and we will be delighted to assist you further.

Contents

LATCHES AND HANDLES	04		
Lever Latches	04	L-Handles	11
Compression Latches	05	Handles	12
<u>Eberhard:</u>		<u>Rohde:</u>	
Compression Latches	06	Function Handles	13
Rotary Latches	07	Paddles Handles	15
Quarter Turn Latches	08	Drop T Handles	15
Swing Handles	09	Push to Close Latches	16
T-Handles	10	Slam Latches	17
		Spring Bolt Latches	19

ELECTRONIC LATCHES	20		
<u>Southco:</u>			
Electronic Access Systems	20		

HINGES	22		
Butt Hinge	22	Bullet Hinge	24
Lift off hinge	22	Diecast Hinge	25
Gate Hinge	22	<u>Southco:</u>	
Pintle Hinge	22	Posititon Control Hinge	25
Piano Hinges	23	Constant Torque Hinge	25
Plastic Hinges	24	<u>D.G.N.</u>	
Concealed Hinge	24	RV Hinges	26

KNOBS & HANDLES	27		
<u>Rencol:</u>		Index Clamping Handle	29
Knobs and Handles	27	Bridge Handles	30
		Index Plungers	31

MISCELLANEOUS	32		
Folding Steps	32	<u>Tarifoldpro:</u>	
Cover stay	32	T-Clip Fasteners	35
<u>Sugatsune:</u>		Adhesive Foam	36
Soft Down Stay	33	Pinchweld	36
Lashing Ring	34	Levelling Feet	37
Anti-Luce	34	Castor Wheels	38
Quarter Turn Fasteners	34		

Contents

NON- THREADED FASTENERS	39		
Clevis Pins	39	Wire Lock Pins	40
Lynch Pins	39	Tab Lock Pins	40
Positive Lock Pins	39	Lanyards	40
Detent Ring Pins	39	Pull Pins	41
Ring Pins	39	Cotters	41
Slic Pins	39		

DRAWER SLIDES	42		
<u>Accuride Drawer Slides:</u>			
Light Duty	42		
Medium Duty	44		
Heavy Duty	46		
Special Products	47		

LINEAR RAILS	48		
<u>Rollon</u>		<u>Hegra</u>	
Linear Line	48	Telescopic & Linear Slides	53
Telescopic Line	50		
Actuator Line	51		

GAS STRUTS	54		
<u>Stabilus:</u>			
Gas struts	Lift-o-mat	54	
Gas struts	Bloc-o-Lift	56	

TOGGLE LATCHES	57		
<u>Frigerio Ettore S.p.A.:</u>			
Toggle Latches	57		
Misc Toggle Latches	58		
Hasp Toggle Latches	59		
Adjustable Toggle Latches	60		
Adjustable over-centre latches	60		

Latches & Handles

LEVER LATCHES



10207 - Large
102.8mm x 50mm; Available in
Chrome and Black Powder Coated



10208 - Small
80.2mm x 35.2mm; Available in
Chrome and Black Powder Coated



southco
C5 Series
Sealed Lever Latches; Available in a
variety of sizes & finishes; key & tool
locking or non-locking options



southco
A7 Lever
Compression Latch
Over-centre action; gasket compres-
sion; available in a variety of
materials; locking or non-locking



southco
C2 Series
Lever Latches; Available in a variety
of sizes & finishes; locking or
non-locking options

Latches & Handles

COMPRESSION LATCHES



southco
62 Series
Lift & Turn Compression Latches;
Available in a variety of styles, sizes
& finishes; locking or non-locking
options



southco
E3 Series
VISE ACTION® Compression
Latches; Available in a variety of
sizes, head styles & finishes; key &
tool locking or non-locking options



southco
N2 Series
Heavy Duty Lift & Turn Compression
Latch; Available in a variety of
sizes & finishes; key locking or
non-locking options

Latches & Handles

EBERHARD

COMPRESSION LATCHES



P-28630 Ergo Whaletail T Handle

Compression Handle available in Stainless Steel / Chrome or Black textured / chrome finish; Two lengths of cam available; Manual or Powered up operation; Three point locking;

ALSO AVAILABLE AS A POWER UP KIT INCLUDING:

ERGO WHALETAIL T-HANDLE
RADN ACTUATOR
ERGO BRACKET
2X RODS & ROD GUIDES
ERGO PINS & WASHERS

Latches & Handles

ROTARY LATCHES



Compact Rotary 200

Zinc plated housing; Ideal for small doors, panels & lids; Max. Load 100 lbs.; requires 0.38 inch striker



Rotary Latch 1-475-L(R)

Dual Stage low profile rotary latch; Available left or right hand; Meets FMSS 206 standard; Requires 0.50 inch striker. Body 3.88 inch long



240 Mini Rotary Latch

Pawl with horizontal travel; Left or Right available; 240 Dual Stage; 241 Single Stage; requires 0.38 inch striker. Body 2.5 inch long; Available w/ different actuator arms



Paddle Rotary Latch 4373

Paddle Handle with Rotary Latching function; Requires 0.55 inch dia striker; available in stainless steel & zinc plated carbon steel; locking or non-locking options available

Latches & Handles

QUARTER TURN LATCHES



118 Series
Quarter Turn Latches available in a selection of tool key options; Cam styles for grip between 18mm - 32mm. Full range of accessories available: Cams and keys.



E5 Series Cam Latches
Available in a selection of materials, styles, lock options and cam sizes. Full range of accessories available: Cams and keys.

southco



37 Series Flexible Draw Latches
Flexible draw latches to absorb & reduce vibrations. Made from EPDB rubber, available in different sizes & designs.

southco



K Series Rotary Draw Latches
Rotary draw latches with lift & turn operation. Available in different sizes & materials with different locking, non-locking options.

southco

Latches & Handles

SWING HANDLES



Diecast Swing Handle 1222-01-10
Black Powder coated Diecast Swing handle. Lockable; Dimensions: 142mm x 32mm



Plastic Swing Handle 1101-1001-C
Plastic Lock body, zinc plated steel shaft & fixing parts; Available in cam, 2-point rod or 3-point rod control; Dimensions: 158.5mm x 33.5mm



Stainless Steel Swing Handle 1205-304
Stainless Steel 304 swing handle Padlockable; Dimensions: 137mm x 32mm



H3 Series
Swinghandle available in a selection of materials & sizes; Available in cam & multi point locking; Padlockable option.

southco

Latches & Handles

T-HANDLES



T-Handle 1317
Bright Chrome; Lockable-keyed differently; Dimensions: 96mm x 33mm



T-Handle T308L
Diecast polished Chrome; Lockable-Clockwise (CW) or Counterclockwise; Dimensions: 100mm x 53mm; 8mm square shaft



T-Handle T302
Diecast Pop Up T-Handle; Lockable Available in Black or Grey; 114.25mm x 69.9mm



T-Handle T101
Diecast polished Chrome; Lockable; 80mm x 45mm

Latches & Handles

L-HANDLES



L-Handle 0.26.0719.0
Diecast Polished Chrome; Lockable; 115mm x 39mm



L-Handle B-120-L
Padlockable L-handle; Diecast Polished Chrome; 114mm



L-Handle 0.26.0628.00
Padlockable L-handle; Diecast Polished Chrome; 105mm



L-Handle 1319-10-10
Diecast Polished Chrome; Lockable; 111.5mm

Latches & Handles

HANDLES



Bridge Handle 3201-122
Black Polymer Bridge Handle; 122mm hole centres; Selection of other handles available w/ different sizes & materials



Grab Handle CLLH-1048
Aluminium diecast handle; hole centres 100mm or 135mm;



P2 Series
Flush Pull Handle; Black ABS plastic; Snap In installation;

southco®

Latches & Handles Rohde



FG7 Handle Series
Function handle w/ one or two push buttons; available w/ emergency stop or without; 3 different connection options; 160mm hole centres



FG11 Handle Series
Function handle w/ push button; available w/ red or green LED; raised or flush button; 8 pin connector plug or cable version; black polyamide; 160mm hole centres



FG12 Handle Series
Function Handle w/ push button & 3 colour LED lighted handle; black polyamide, aluminium & illuminable insert of translucent PMMA; 8 pin connection cable; 165mm hole centres

Latches & Handles Rohde



FG14 Handle Series
Modular Function handle; available w/ up to 3 push buttons, labelling with different light options; emergency stop button option; 12 pin connector or cable; 300mm hole centres



KW Handle Series
Plastic Handles for one sided mounting; available in 2 sizes; black polyamide; weight rating 800N



U4 Handle Series
For mounting on edges; horizontal or vertical; available in different sizes; aluminium in black or natural; weight rating 800N

Latches & Handles

PADDLE HANDLES



10407 or 10408 Paddle Handle
Stainless Steel Handle; Lockable or Non-locking; Size: 92.10mm x 120.70mm



10409 or 10410 Paddle Handle
Stainless Steel Handle; Lockable or Non-locking; Size: 108mm x 139.50mm

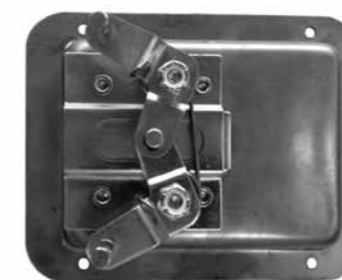

10411 or 10412 Paddle Handle
Stainless Steel Handle; Lockable or Non-locking; Multi-point; Size: 108mm x 139.50mm



10507
Polished Stainless Steel; Non-locking; 120.8 x 92.2mm



DROP T-HANDLES

10502SS
Polished Stainless Steel; Mounting holes or stud mounting; Available in different key combinations; Non-locking version available.

Latches & Handles

southco®

PUSH TO CLOSE LATCH



R3 Series
Baggage Door Latch; Pull to open; Zinc Alloy in Black or White powdercoated or chrome plated; Non-locking or locking different key options available



AC-15
Surface Mount Actuator; Direct pull actuation; Multiple key codes & non-locking option



R3 Series
Entry Door Latch; Inside/Outside access; Pull to open; Zinc Alloy in Black or White powdercoated or chrome plated; Locking



AC-40
Push-Button Handle; Zinc Alloy or stainless steel; Single or multi point actuation; Multiple key code options



AC-10
Flush Mount Actuator; Single, multi-point or direct pull actuation; Multiple key codes & non-locking option



AC- Single Point
Push-Button Single Point Actuator; Flush installation; Black PC/ ABS

Latches & Handles

SLAM LATCHES



RTH-00003
Ring Pull Slam Latch; Yellow Zinc plated steel base; Dimensions: 34.1mm x 41.2mm Reversible tongue



A90 Series
Slide latching hardware; Dimensions: 90mm x 56mm; Available in 3 Grip lengths



10402
Zinc plated steel base; Dimensions: 53mm x 44.5mm; Reversible tongue



A30 Series
Slide Slam latching hardware; Dimensions: 47mm x 28mm; Available in 3 Grip lengths



10403
Black Powder coated steel base; Dimensions: 53mm x 41mm; Ideal for 3-point latches



A55 Series
Slam latching hardware; Dimensions: 57mm x 42mm; Available in 2 Grip lengths

Latches & Handles

EBERHARD.

SLAM LATCHES



561
Die cast slam latch; uses 0.31 inch dia rod; load rating 100lbs



563
Die cast slam latch; uses .375" dia rod; load rating 750lbs



626
1/4 TURN SLAM LATCH; key locking; water resistant; black plastic with stainless steel dust shutter; 90 degree rotation



628 Series
Push Button slam latch; key locking; water resistant black plastic; available with or without vertical finger pull.



682 Series
Two Point Push Button; Chrome button, black bezel, black finger pull. Stainless steel shutter; water resistant; key locking

Latches & Handles

SPRING BOLT LATCHES



F6 Series
Southco Door Removal Hinge; Single sided or double sided; Zinc Plated or Stainless Steel; Left & Right Hand option

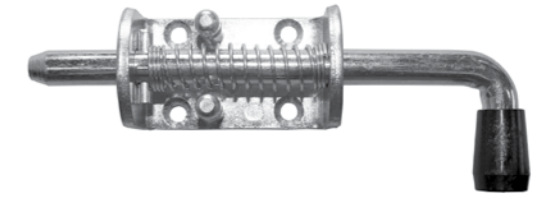

D12-A
Zinc plated Steel; 12mm dia. Pin; Dimensions: 74mm x 40mm; Suitable for Left Hand or Right Hand application

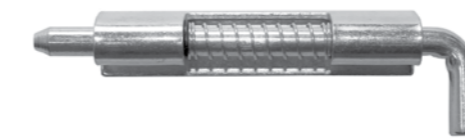

RTH-00004
Zinc plated steel; 6.35mm dia. Pin; Dimensions: 70mm x 14.7mm



H00117-2
Zinc plated steel; 6mm dia. Pin; Dimensions: 30mm x 10mm; Left & Right Hand available (LH shown)



RTH-00005
SS304 Pin, Base, Spring & Stopper; 10mm dia. Pin; Dimensions: 58mm x 30mm; Suitable for Left Hand or Right Hand application



H00117
Zinc plated steel; 6mm dia. Pin; Dimensions: 63mm x 22mm; Left & Right Hand available (LH shown)

Electronic Latches

southco®

ELECTRONIC ACCESS SYSTEMS



H3-EM- Electronic Locking Swinghandle
RFID Card reader option; Local remote monitoring; Single or multi point latching; manual override



EM-05 & 10 Electronic Slide Bolt
Push to Close; Side and front mount available; Mechanical override; Single or multi-point latching



Electronic Access Controllers
Keypads; RFID Card Readers; USB Input; RF Controllers; Wiegand Inputs



SC Series
Self Contained Electronic Locking System; Battery operated; Selection of access options and materials available.

Electronic Latches

southco®

ELECTRONIC ACCESS SYSTEMS

R4-EM Electromechanical Rotary Latches Series

CAD DRAWINGS AVAILABLE



1&2 series
All-metal construction; Push to close operation and electronic actuation



9 Series
Internal Micro processor; trigger sensor for status reporting



4&6 series
Compact & Lightweight; push to close operation; auto re-lock and delayed re-lock options available



5&7 series
For Outdoor use; Corrosion resistant & fully sealed. Allows integration with an external control system

LATCHES & HANDLES
ELECTRONIC LATCHES
HINGES
KNOBS
MISC.
NON-THREADED FASTENERS
DRAWER SLIDES
LINEAR RAILS
GAS STRUTS
TOGGLE LATCHES

LATCHES & HANDLES
ELECTRONIC LATCHES
HINGES
KNOBS
MISC.
NON-THREADED FASTENERS
DRAWER SLIDES
LINEAR RAILS
GAS STRUTS
TOGGLE LATCHES

Hinges

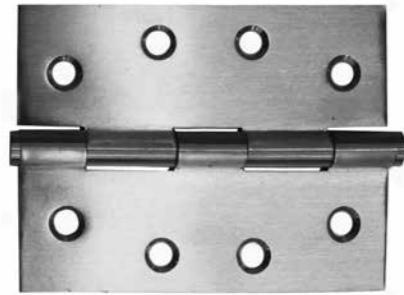

Butt Hinge
Available in Mild steel, Zinc Plated, Stainless Steel. Fixed or Loose Pin and variety of sizes - please see website for more details.



Lift Off Hinge
In Mild Steel or Stainless Steel; Left or right hand;



Gate Hinge
In Stainless Steel; Left or right hand; 2.5mm X 75mm X 100mm



Pintle Hinge
Brass Hinge Chrome Plated & black option; Available in a variety of sizes & designs

Hinges

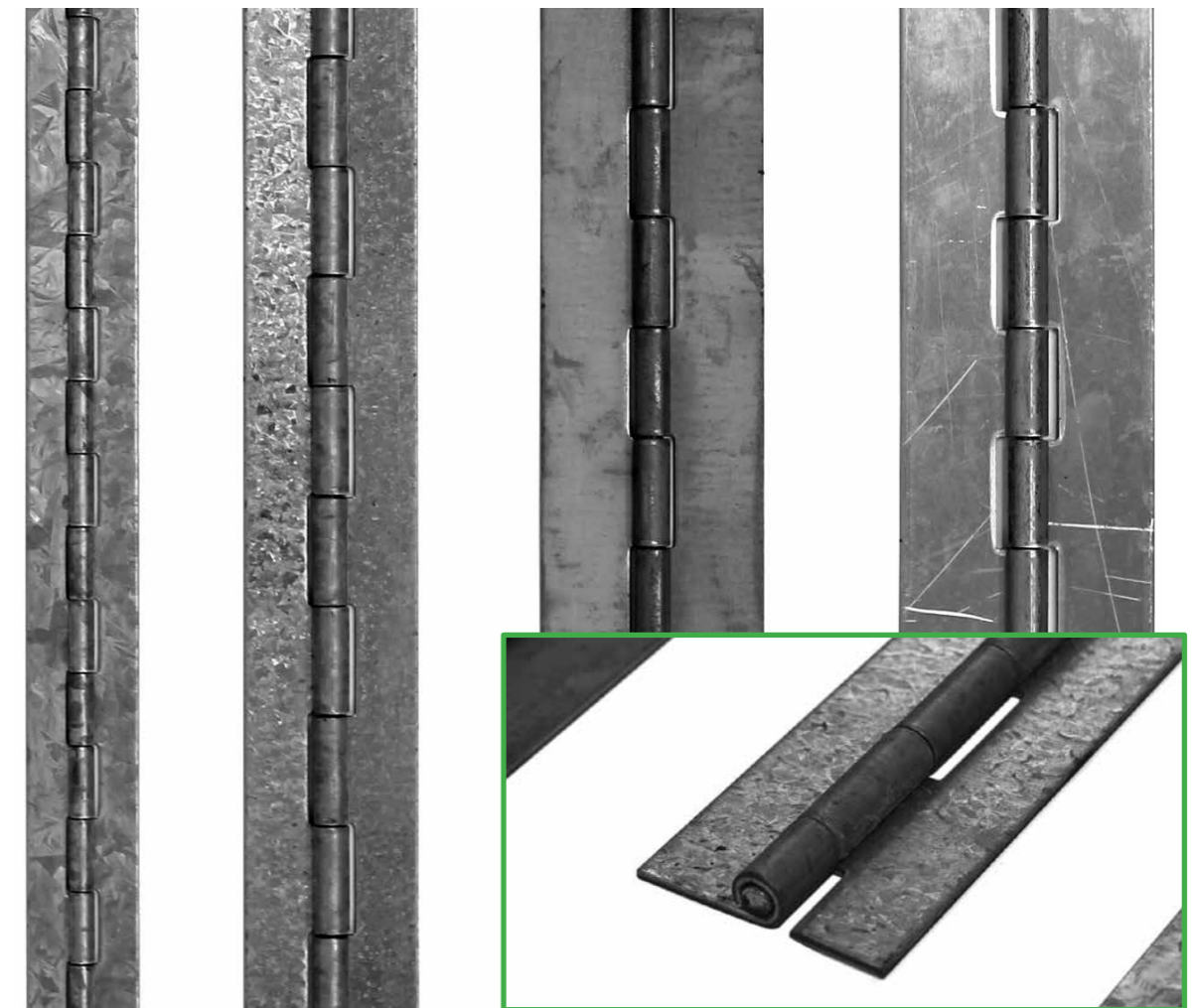

Piano Hinge

The LLH Series of Continuous Hinges are designed for use in the commercial, domestic, military or other applications where a reliable hinging system is required.

The hinge can be easily customised to suit any applications.

Material Options:

- Galvanised Steel
- Mild Steel
- Aluminium
- Zinc Anneal (untreated)
- Stainless Steel 304 or 316
- Nickel Plated

Material Thickness (gauge): 0.9mm, 1.0mm, 1.2mm, 1.6mm, 2.0mm, 3.0mm, 4.0mm. Hinge Open Width: As required. Hinge Length: As required.

Customisation: Hole placement, hole sizes & shapes, bending and special cut outs are offered to our customers as required per application.

Hinges



Black Polyamide Hinge
Available in a variety of sizes
25, 30, 40 or 50mm

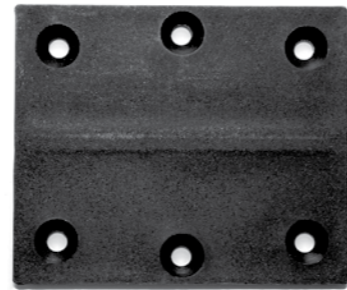

Pinless Butt Hinge
Modified Polyolefin Copolymer;
Available in black or white and a
variety of sizes



Plastic Continuous Hinge
Modified Polyolefin Copolymer; Avail-
able in black or white. Variety of width;
Rolls of 25ft, 50ft or 100ft



Panel Cutout
1.7- 2mm material thickness;
Zinc die cast black powder coated

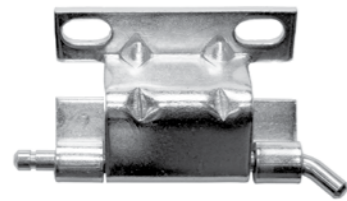

Concealed Hinge
Mild Steel Zinc Plated passivated
or Stainless steel



Bullet Hinge
Available in Aluminium or Steel;
different lengths w/ grease nipple
or without

Hinges



Diecast
Variety of sizes and leaf options available; stud or hole mounted



C6 & G6 Position Control
Detent Hinge; Stainless Steel or Hardened Steel Detent Tube; Variety of opening
degrees and positioning torque strength



southco®



E6 Constant Torque
Variety of sizes & materials available; Different Torque strength, available in
Symmetric and asymmetric torque



southco®

Hinges

D.G.N.



RV Position control 2854
170 degree, Hidden, adjustable position control hinge; self-closing; available springloaded or not; nickel plated or stainless steel.



RV Hinge 2856
Hinge with horizontal joint, 2 springs, position stop and very soft movement.



RV Hinge 2912
Adjustable opening angle 75 - 95 degrees; soft opening movement



RV Hinge 2953
Adjustable opening angle from 75 - 95 degrees; Adjustable spring force; Soft closing;

Knobs and Handles

Rencol
COMPONENTS



Scalloped & Lobe Knobs
Male or Female; Model 01 PK - Model 08 PK; Variety of knob sizes, thread types & length available



Metal Knobs
Male or Female; Model 01 MK - Model 08 MK; Variety of knob sizes, thread types & length available



Wing Knobs
Male or Female; Model 15 PK; Variety of knob sizes, thread types & length available



Tri-Star Knobs
Male or Female; Model 10 PK; Variety of knob sizes, thread types & length available



Button Knob
Male or Female; Model 21 PK; Variety of knob sizes, thread types & length available

Knobs and Handles

Rencol
COMPONENTS



Ball Knobs

Male or Female; Model 17 PK - Model 20 PK; Variety of knob sizes, thread types & length available



Taper Knob

Male or Female; Model 22 PK - Model 23 PK; Variety of knob sizes, thread types & length available



Thumbscrew Knob

Male or Female; Model 24 PK - Model 28 PK; Variety of knob sizes, thread types & length available



T-Handle Knobs

Male or Female; Model 01 PH & Model 02 PH; Variety of knob sizes, thread types & length available



Star Knobs

Male or Female; Model 11 PK - Model 12 PK; Variety of knob sizes, thread types & length available



Knobs and Handles

Rencol
COMPONENTS



Self Assembly Knob

Model 29 PK- Model 31 PK; Variety of knob sizes, thread types & length available



PVC Grip

Model 01 PG & Model 02 PG; Variety of knob sizes, thread types & length available



Index Clamping Handle

Male or Female; Model 01CH & Model 05 CH; Variety of knob sizes, thread types & length available



Index Cranking Handle

Female; Model 06 CR & Model 09 CR; Variety of knob sizes, thread types & length available



Spoked Control Handwheel

Female; Model 01 HW & Model 04 HW; Variety of knob sizes, thread types & length available

Knobs and Handles

Rencol
COMPONENTS



Revolving Handles

Male or Female; Model 03 PH & Model 08 PH; Variety of knob sizes, thread types & length available



Bridge Handle — *Model 03 BH shown*
Model 01 BH - Model 10 BH;
variety of styles, sizes, materials and
thread types



Bridge Handle — *Model 01 BH shown*
Model 01 BH – Model 10 BH; Variety of
styles, sizes, materials & thread types
available.



Bridge Handle — *Model 11 BH shown*
Model 11 BH - Model 22 BH;
Variety of styles, sizes, materials and
thread types available



Bridge Handle — *Model 19 BH shown*
Model 11 BH - Model 22 BH;
Variety of styles, sizes, materials and
thread types available

Knobs and Handles

Rencol
COMPONENTS



Spring Loaded Index Plunger

Model 01 IP & Model 02 IP; Available
with or without locking rest position;
Burnished steel or stainless steel;
Variety of sizes available



Index Plunger w/ fixing plate

Model 03 IP; Available with or without
locking rest position; Variety of sizes
available



Spring Loaded Ring Pull Plunger

Model 05 IP; Zinc Plated w/ stainless
steel pin; Variety of sizes available



Cam Plunger

Model 04 CP; Burnished steel or
stainless steel; Variety of sizes available



Threaded Ball & Spring Plunger

Model 06 IP; Burnished steel or stainless
steel; Variety of sizes available



Body Index Plunger

Model 07 IP; Available with or without
locking rest position; Zinc plated or
stainless steel body; Variety of sizes
available

Miscellaneous

FOLDING STEPS



EBERHARD

585809- Series
Available in a Galvanised finish
Serrated surface to prevent slipping
Overall size - 6.50 x 6.60 inches



FS19421
Available in a Galvanised finish
Serrated surface to prevent slipping
Overall size - 220mm x 170mm

COVER STAY



6102
Nickle Plated Mild Steel
268mm Open; Available in Left Hand
& Right Hand



6103
Nickle Plated Mild Steel
134mm Open; Available in Left Hand
& Right Hand

Miscellaneous

SUGATSUNE

SOFT-DOWN STAY



Sugatsune NSD-10
Adjustable Soft-Down Stay; Soft-down
speed & opening angle is adjustable



Sugatsune SDS-C301N
For upward opening door; holds door
in closed or open position; Steel, zinc
alloy, plastic in black or white



Sugatsune HDSN-30
Heavy Duty for upward-opening lids
holds door in closed or open position;
Available in different torque strength;
Steel & light grey plastic



Sugatsune SLUN-N
Vertical Swing Lift-Up Mechanism;
helps lift doors & holds in open
position; Adj. mounting plate; available
for different weight ranges; steel &
grey plastic

Miscellaneous

LASHING RING

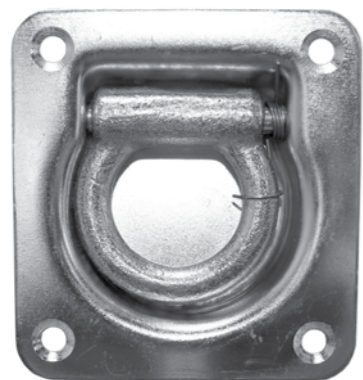

39530
Available in Zinc Plated Steel or Stainless Steel 304; With Holding Spring; Breaking Load 2000 kgs

ANTI-LUCE

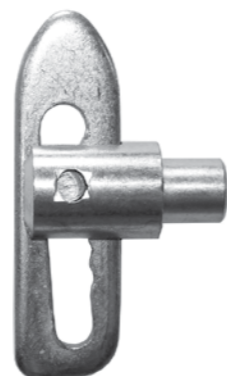

53000 Series
Available in Zinc Plated Steel or Stainless Steel 304 Available in "Bolt-on" or "Weld-on" option

QUARTER TURN FASTENERS



Bi-Fix Quarter Turn Fasteners
Variety of head styles, sizes, fixing options & accessories available



DZUS® Lion Quarter-Turn Fasteners
Variety of head styles, stud lengths, receptacle styles and accessories available



Miscellaneous



TARIFOLD FASTENERS



T-Clip
Clip allows to mount numerous objects on almost any aluminium profile; Fix without tools; repositionable without damage to profiles; Holds weight up to 5KG; Profile thickness of 1.25 - 8.5mm; 8 or 10mm clips available



Hook Holder
Hook for work station optimisation & organisation; Attach with T-Clip; Hard-wearing 304 stainless steel; 24mm X 53mm



Magnetic Holder
Magnetic Holder to keep anything metallic exactly where you need it.; Attach with T-Clip; Stable; Anti-rotation function; Install horizontal or vertical;

Miscellaneous

ADHESIVE FOAM



High Bond Adhesive Neoprene, Polyethylene & PVC Tape; Long term waterproof seals, absorbing vibrations & providing noise dampening effects; Available in a variety of sizes - up to 6mm thickness & 1300mm wide; Density options of soft, medium or hard.

PINCHWELD

60-053SCH

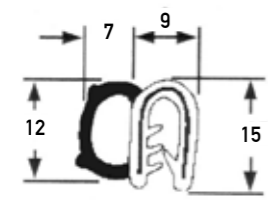

66-006

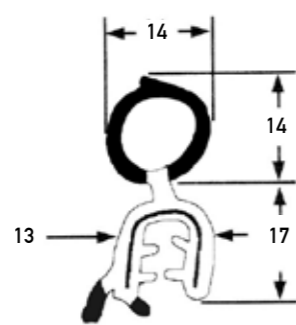

66-014

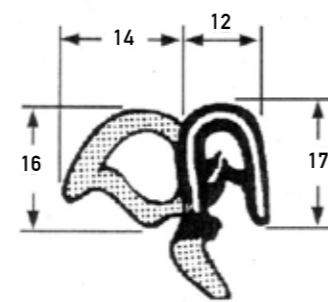

60-037

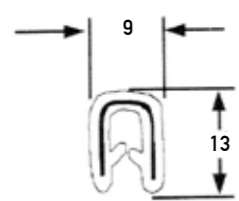

66-008

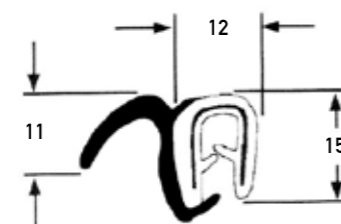

66-003

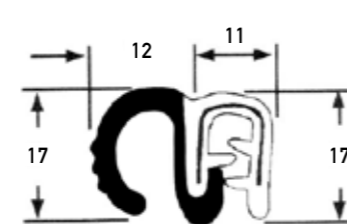

Pinchweld

EPDM Rubber & Sponge; Comes in 50 Metre rolls; Large selection of profiles - Please check our website for all available profiles & sizes

Miscellaneous

LEVELLING FEET



Model 01 LF

Glass reinforced nylon leveling foot; Free Standing or bolt down option; available in a selection of sizes, length and load ratings.



Model 02 LF

Die cast zinc black leveling foot; Free Standing or bolt down option; available in a selection of sizes, length and load ratings.



Model 03 LF

Stainless steel leveling foot; Free Standing or bolt down option; available in a selection of sizes, length and load ratings.



Model 04 LF

Polypropylene leveling foot; Rigid Adjustable; with round or hex base; available in a selection of sizes, length and load ratings.



Model-01-TR

Zinc plated threaded rods; available in a selection of thread length & sizes



Model 01NPB TB

Threaded Bush with nickel plated brass insert; black glass enforced nylon; available in a selection of bush & thread sizes

Miscellaneous

CASTOR WHEELS



KS Series
Stainless Steel castor frames; 75 kg load rating; selection of mounting options; solid virgin nylon 6 tread or thermoplastic elastomer tread available; 75 mm Dia. X 25mm width wheel



M & H Series
Heatmaster castors; zinc plated or stainless steel frames; load rating 150 - 400kg; variety of wheel materials, types & sizes available; withstands 260 degrees continuous & 300 degrees intermittent heat;



Heavy Duty Series
Premium heavy duty forged swivel head castor; zinc plated frame; load rating 450 - 1500KG; variety of wheel materials, types & sizes available



H Series
Heavy duty castors; zinc plated frames; on/ off brake metal pedal; load rating 150 - 550 KG; variety of wheel materials, colours, types & sizes available

Non-Threaded Fasteners



Clevis Pin
Clevis Pins are available in a variety of styles & sizes w/ grooves or holes; Carbon steel or stainless steel; Custom made options available.



Lynch Pins
Lynch Pins are available in a variety of sizes; Zinc plated & yellow chromate dipped low carbon steel;



Positive Lock Pins
Positive Pins are available in a variety of sizes; Zinc plated & yellow chromate dipped low carbon steel; Push button for retraction; Double ball design



Detent Ring Pins
Detent Ring Pins are available in a variety of sizes; Zinc plated steel; ball detent that depresses and springs back up for "quick release" applications



Ring Pins
Ring Pins are available in a variety of styles & sizes; Zinc plated steel; Can be combined with our cotter range



SLIC Pins
Self Locking Implanted Cotter Pin are custom made as required; Variety of styles, diameters & materials available.

Non-Threaded Fasteners



Wire Lock Pins

Wire Lock Pins are available in a variety of sizes, square or round; low carbon steel cold-headed pin w/ spring wire loop, zinc plated



Tab Lock Pins

Tab Lock Pins are available in a variety of sizes, square or round; low carbon steel, zinc plated; Wire loop of hard drawn spring wire



Lanyards

Available in a variety of styles, sizes, length & materials (Nylon, Galvanized Steel or coated with PVC); different end options: eyelets, loops or a combination of these

Non-Threaded Fasteners



Pull Pins

Pull Pins are available in a variety of sizes; Zinc plated steel;



Auto-Lock Safety Pull Pin

Auto-Lock Safety Pull Pins are available in 1/2 pin dia; Zinc plated low carbon steel; locks into an extended (forward) position automatically



Bow-tie Locking Cotter

Bow-tie Locking Pins are available in a variety of sizes; low carbon steel, zinc plated MB spring wire; Locks itself on, snaps into a zero tension locked position, easily removed by lifting loop and sliding off.



Hair Pin Cotter

These cotters are available in a variety of sizes; zinc plated MB spring wire or 302 stainless steel.



Double Loop Hair Pin Cotter

These cotters are available in a variety of sizes; zinc plated MB spring wire.



Rue Rings Cotter

These cotters are available in a variety of sizes; zinc plated MB spring wire or 302 stainless steel.

Drawer Slides

Accuride

LIGHT DUTY



204-ALR
3/4 Extension Drawer Slide, Lock out, Disconnect,
64kg load rating
AVAILABLE LENGTHS: 12"-28" (305 - 711mm),

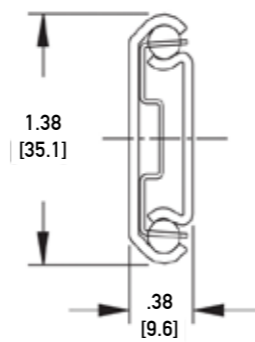

2601
Full Extension Drawer Slide.
34kg load rating; Hold detent;
AVAILABLE LENGTHS: 8"-22" (200 - 500mm)

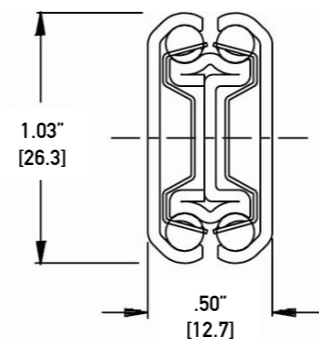

3630
Two way travel drawer slide; 45kg load rating;
Hold in detent at centre; Non-disconnect;
AVAILABLE LENGTHS: 16"-28" (400 - 700mm)

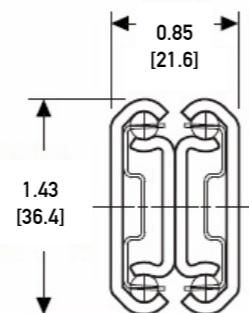

Drawer Slides

Accuride

LIGHT DUTY



2907
Low Profile; Narrow Drawer Slide Space.
52kg load rating; 2" Over Travel;
Disconnect; Lock out;
AVAILABLE LENGTHS: 12"-30" (305-762mm)

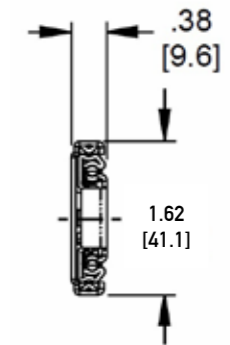

3832HDSC
Self Closing Drawer Slide, Disconnect; 45kg
Load Rating; AVAILABLE LENGTHS: 6"-28"
(148-700mm)

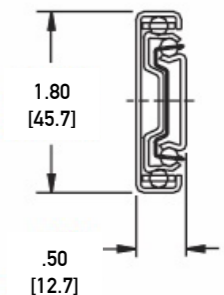

3832HDTRP
Touch to Open Drawer Slides. 45kg load rating;
Disconnect; Self Close;
AVAILABLE LENGTHS: 6"-28" (148-700mm)

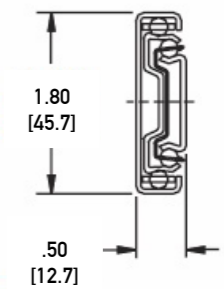

Drawer Slides

Accuride

MEDIUM DUTY

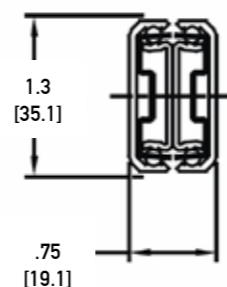
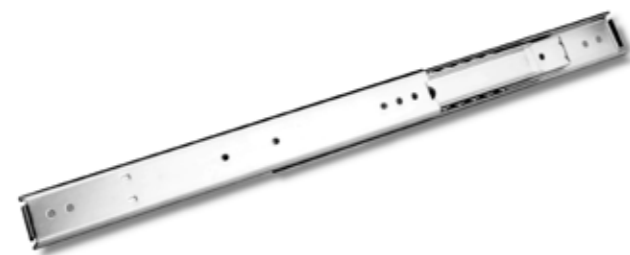

301

Low Profile Drawer Slide. 80kg load rating; .88" Over Travel; AVAILABLE LENGTHS: 12"-28" (305-711mm)

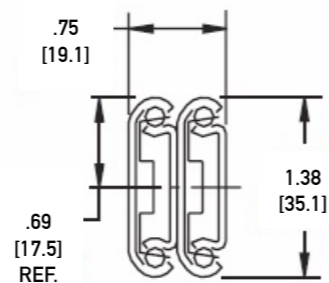

305A-LR

Low Profile Drawer Slide. 64kg load rating; Lock-out; Disconnect; .88" Over Travel; AVAILABLE LENGTHS: 12"-28" (305-711mm)

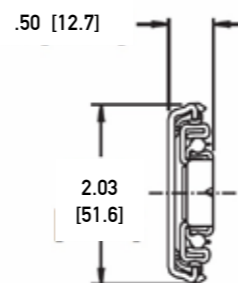

3558

Drawer Slide, 68kg load rating; 1" Over Travel; Lock-in/Lock-out; Lever Disconnect; AVAILABLE LENGTHS: 12"-28" (305-711mm)

Drawer Slides

Accuride

MEDIUM DUTY

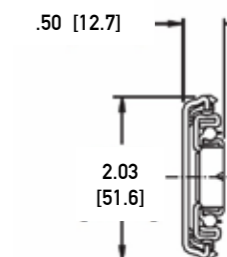

3507

Drawer Slide; 90kg load rating; 2" Over-travel; Lock-out; Latch disconnect; AVAILABLE LENGTHS: 16"-30" (406-762mm)

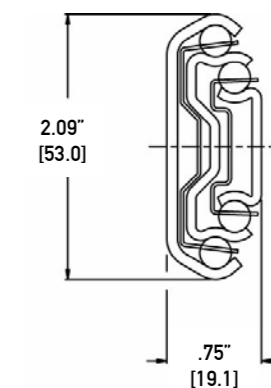

3601

Drawer Slide; 112kg load rating; 1" Over-travel; Non-Disconnect; HOLD-IN DETENT; AVAILABLE LENGTHS: 16"-30" (406-762mm)

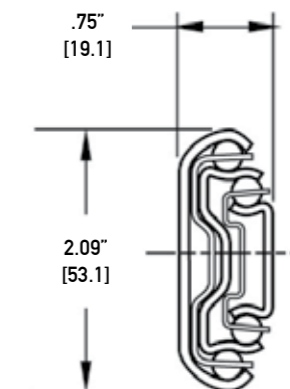

3607

Drawer Slide. 123kg load rating; Lock-out; Lever Disconnect; AVAILABLE LENGTHS: 12"-28" (305-711mm)

Drawer Slides



HEAVY DUTY



9301
 Drawer Slide; 226kg load rating. Non-Locking. Non-disconnect;
 AVAILABLE LENGTHS: 10" - 60" (254-1524mm)

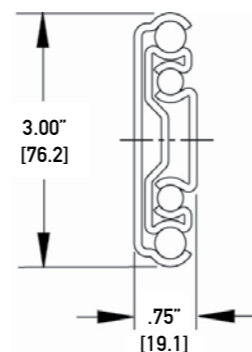

9308
 Drawer Slide; 226kg load rating. Lock-in/ Lock-out. Non-disconnect;
 AVAILABLE LENGTHS: 10" - 60" (254-1524mm)



7957
 Drawer Slide; 159kg load rating. Disconnect; Lever Disconnect;
 AVAILABLE LENGTHS: 16" - 36" (400-900mm)

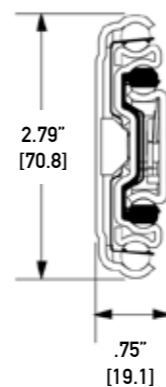

Drawer Slides



HEAVY DUTY



AL4160
 Aluminium Drawer Slide. 300kg load rating. Full Extension; AVAILABLE LENGTHS: 300-1000mm

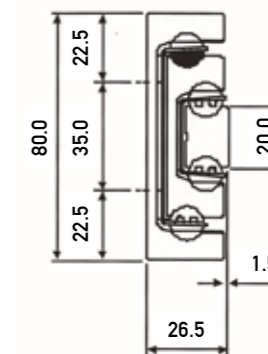

4190
 Tilt Slide; slide and tilt system; Available Length 600 or 1000mm cut to size.

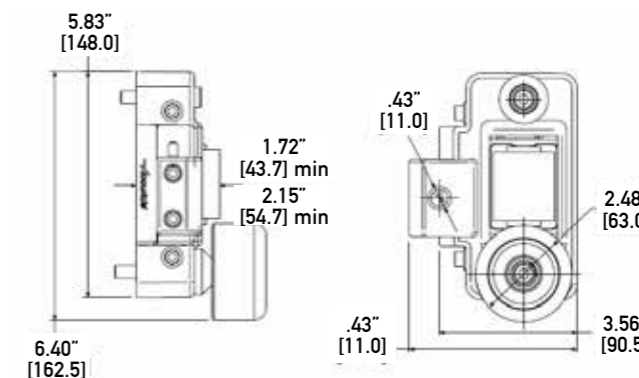

Dbhand
 Accuride double handle kit; lock-in and an optional lock-out for Accuride Heavy Duty or Medium Duty Slides.



Linear Rails

ROLLON®

LINEAR LINE

Linear Line is Rollon's line of linear motion rails. The product range includes linear caged ball bearings and recirculating ball bearings rails, with different profiles and types of sliders.

They are used in a wide range of industrial applications including railway, aerospace, medical, logistics, specialty vehicles and industrial machinery.



EASYSLIDE

Cold drawn steel linear rails with induction hardened raceways; external 'C' profile rail w/ incorporated caged ball bearings; one or more sliders possible per rail; available in a variety of width & length; Suitable when shocks and vibrations are experienced



COMPACT RAIL

Linear rails with high precision ball bearing roller slider; steel linear rails with induction hardened raceways and high precision radial hardened steel ball bearing sliders; Lubricated-for-life roller bearings; Resistant to dirt; 3 different linear rails & 2 slider types to choose; Available in a selection of sizes;



X-RAIL

Linear rails with radial ball bearing sliders; Selection of rails available in either stainless steel or galvanized; different sizes length; Low coefficient of friction; Corrosion resistant; High temperature resistance up to 120°C

Linear Rails

ROLLON®

LINEAR LINE



SYS

Handling system consisting of aircraft aluminum alloy guides with high mechanical features & hardcoat anodized surface with wheel-based rolling blocks; available in various configurations according to load; internal or external slider



CURVILINE

Curvilinear rails with radial ball bearing rollers; Two rail widths: 16mm and 23mm; Zinc plated rails & sliders as per ISO 2081; Strokes over 3,000mm; Straight and curved paths in one rail available



MONORAIL

Profiled linear rail for high precision under heavy loads. Four rows of balls run in the self-lubricated slider; available in a variety of width & length; corrosion and dust resistant; sealed lubrication cycle

Linear Rails

ROLLON®

TELESCOPIC LINE

The Telescopic Line contains Rollon's full and partial extraction telescopic guides. The linear guides come with hardened raceways, and different profiles of the rail and of the central component for a variety of requirements.

They are used in industries, such as railway, aerospace, medical, logistics, special vehicles, industrial machines, building industries, as well as the most demanding home and business furnishing.



TELESCOPIC RAIL

TELESCOPIC RAIL linear slides exhibit little deflection while under very heavy loads, even when fully extended. guides come in eight different series; Over-extending, full or partial telescopic strokes are available; supported load up to 2,000KG; Special versions and strokes available upon request



OPTI RAIL

Full extraction telescopic rails, extremely compact with rigid steel ball bearings for high load capacity; Smooth and quiet operation; 2 Opti Rail versions available; one fixed & one mobile rail each available with a central Double T or S element.



LIGHT RAIL

The Light Rail has full or partial extension lightweight telescopic guides; Optional locking mechanism for open or closed positions; Various designs, maximum stroke 1,100mm. Over extension available up to 105%

Linear Rails

ROLLON®

ACTUATOR LINE

The Actuator Line is the Rollon speciality product line dedicated to linear actuators and linear motion systems. Featuring extruded aluminum profiles; available in different types of belt and ball screw driven models and configurations. The functions, high operational performance, load capacity and precision allow Rollon actuators to be used in a wide range of applications in the automation industry, specifically industrial machines: pick and place packaging, production lines and assembling operations.



UNILINE SYSTEM

Compact size & high speed units; a self-sustaining extruded aluminum profile. The linear units are driven by a steel reinforced polyurethane belt system. Available in different lengths



ECO SYSTEM

Linear actuators of self-sustaining extruded aluminum frame, driven by a polyurethane belt; Different versions & sizes available.



PLUS SYSTEM

Highly protected units; anodized aluminum structure & steel re-enforced driving belt; Sturdy & high performance actuators for load, movement control, speed & acceleration. Series of different systems available.



CLEAN ROOM SYSTEM

Linear actuators with belt driven transmission, specifically designed for Clean Room applications



SMART SYSTEM

High performance, simple linear units with steel re-enforced driving belt

Linear Rails

ROLLON®

ACTUATOR LINE



PRECISION SYSTEM

Self-sustaining profile systems made of extruded aluminum & steel for the TK series, able to ensure excellent precision. The motion is achieved by means of precision rolled recirculating ball screws.



MODLINE

Linear axis with belt drive or screw drive. Rolling on trapezoidal, round or recirculating ball guides.



TECLINE

Linear axis with rack and pinion transmission. Rolling on trapezoidal or recirculating ball guides.



MODLINE Z

Vertical axis with belt transmission. It includes axis with pneumatic counter balance.

Hegra Linear Group

HEGRA

TELESCOPIC & LINEAR SLIDES

Hegra is one of the leading manufacturers of heavy duty linear guiding systems and heavy duty telescopic slides for industrial, automotive, machinery and airplane manufacturing and for many other applications.

Available are:
Part extensions,
Full extensions,
Heavy duty slides,
Linear guiding systems,
Over extensions,
Stainless steel options
and S-profile slides
in a variety of sizes,
weight ratings and
length; Side & bottom
mounting possible.

PART EXTENSIONS

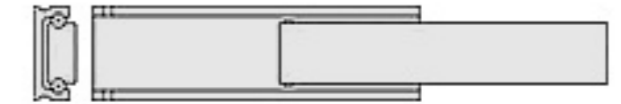

FULL EXTENSIONS

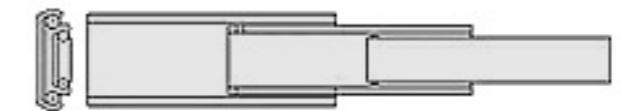

OVER EXTENSIONS

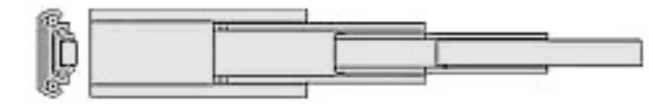

HEAVY DUTY SLIDES



LINEAR GUIDING SYSTEMS

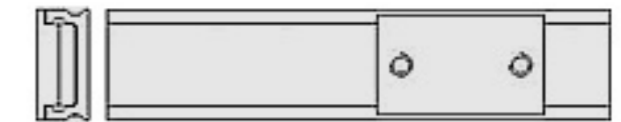

S-PROFILES



Gas Struts

STABILUS

LIFT-O-MAT GAS SPRING

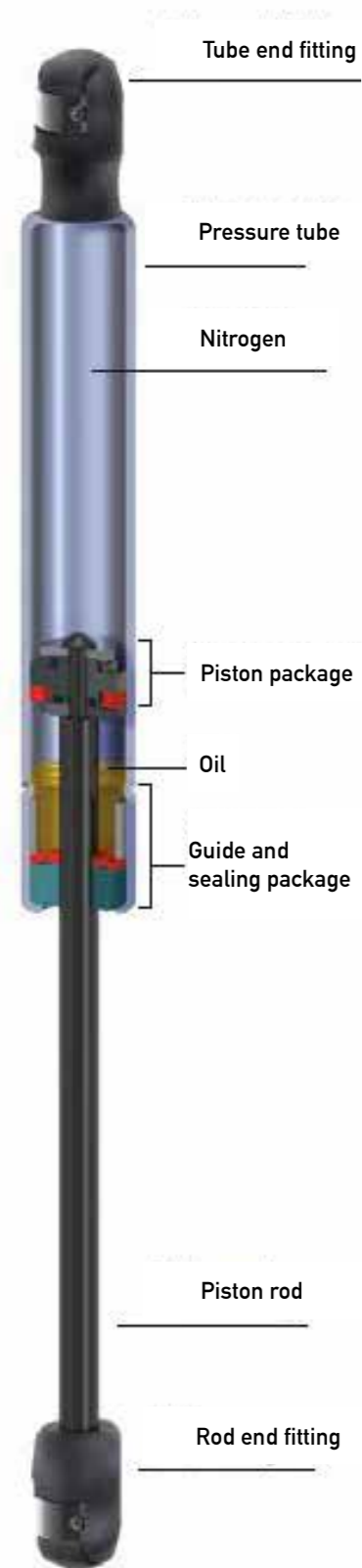

Concept Latch, Lock & Hinge is proud to be an authorised dealer for Stabilus

Lift-O-Mat Gas Spring

LIFT-O-MAT gas springs are non-locking gas springs.

It can control the extension force and damping action, ensuring user-friendly motion sequences.

Areas of application are doors and flaps in mechanical engineering and process technology, the automotive sector, medical technology, the furniture industry and many other applications.

Optimized weight compensation during lifting, lowering, opening, and closing actions.

Broad range of sizes and force variants available as standard products.

Compact form for installation in small spaces.

For each of our gas springs and dampers, there are numerous variants to configure the product to meet your requirements.

A variety of strokes, lengths, diameters and different fittings made from metal or plastic (K1 - K7 and D1 - D7) are available. Optional guard or locking tubes (S1 or S2) are also available.

Please see our website for all the options and Stabilus accessories.

Gas Struts

STABILUS

LIFT-O-MAT GAS SPRING

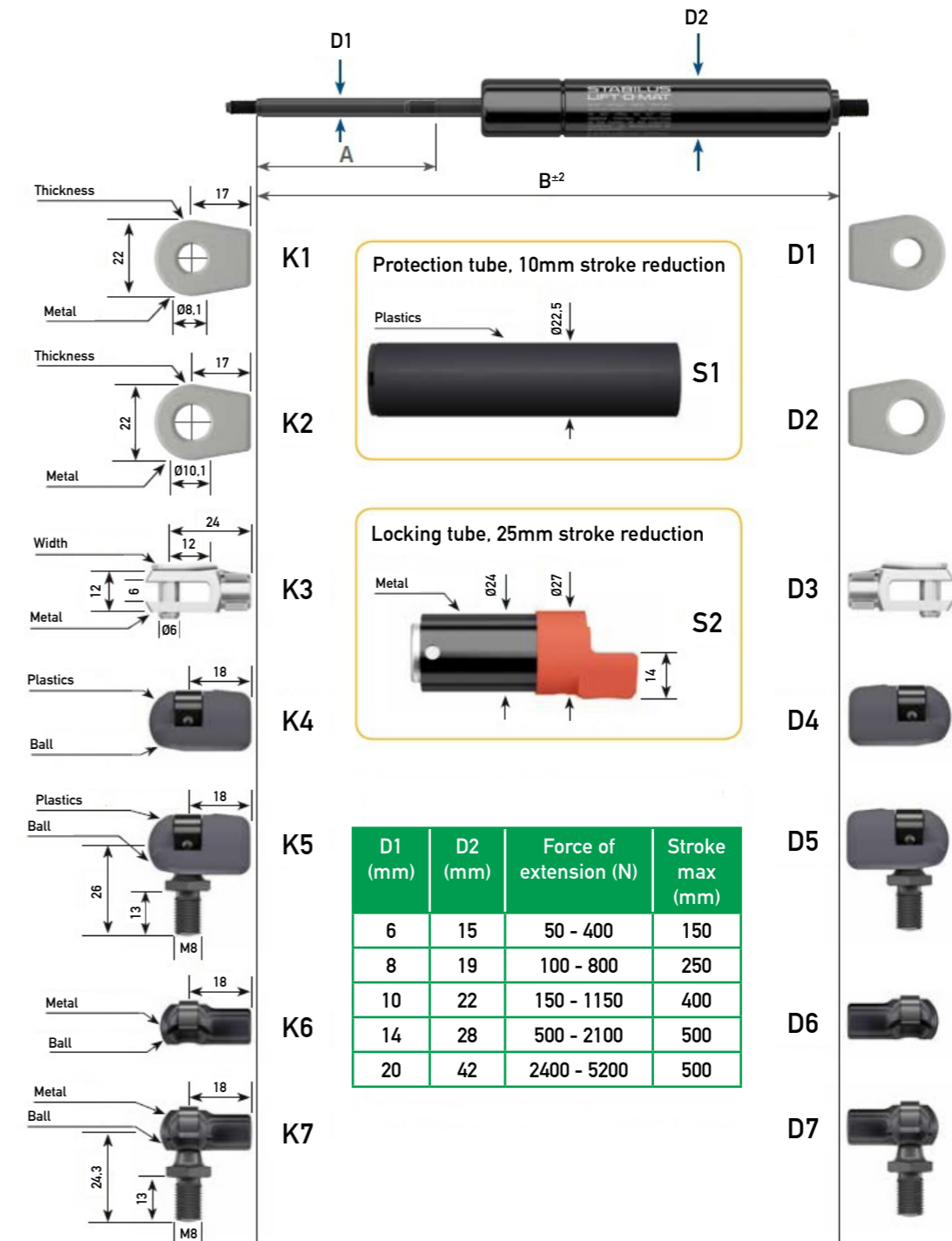

Ordering example:

123456	0350N	K2	D1	S1
Ref. No.	F ₁	Piston rod end fitting	Pressure tube end fitting	Optional tube

Gas Struts

STABILUS

BLOC-O-LIFT — LOCKING GAS SPRING

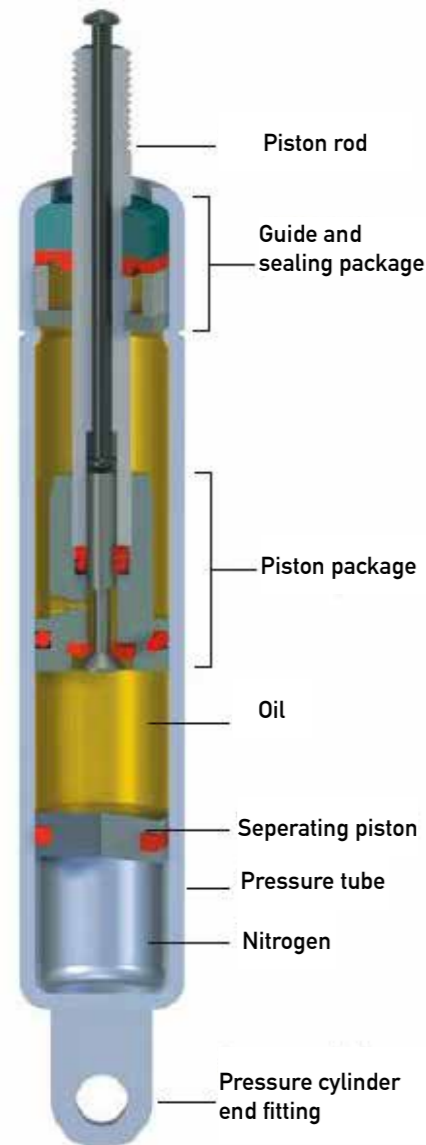

A variety of strokes, length, stroke & tube diameters and strength available.

Please see our website for all the details and accessories.

BLOC-O-LIFT Locking Gas Spring

The BLOC-O-LIFT gas springs from Stabilus are locking gas springs.

They are used for applications that require force assist, damping, as well as variable locking. Heavy flaps and lids can be moved easily and held safely in place.

The gas springs feature a special piston/valve system which separates the two pressure chambers. If the valve is open, BLOC-O-LIFT provides force support and damping.

The linear spring characteristic curve will provide an even increase in force over the entire range of motion. If the valve is closed, the gas spring locks and provides very high resistance to any motion.

BLOC-O-LIFT are used in furniture manufacturing, medical technology, building technology, aviation and aeronautics, ship building, automotive design, and many industrial applications.

Advantages and properties:

Variable positioning with elastic or rigid locking in the tension or compression direction

Rigid locking version is available as orientation-specific or non-orientation specific

Different release systems available

Toggle Latches

TOGGLE LATCH



2.02.00

Toggle Latch available in stainless steel; Max Safe Load: 400N. Ultimate Tension: 1000N; Size: 76.5mm x 21mm



2.03.00

Toggle Latch available in zinc plated or stainless steel; Max Safe Load: 500N. Ultimate Tension: 1300N (zinc plated) & 200N (stainless steel); Size: 102mm x 23mm



2.00.00

Toggle Latch available in nickel plated or stainless steel; Max Safe Load: 2000N. Ultimate Tension: 4000N; Size: 193.5mm x 43mm



2.01.00

Toggle Latch available in zinc plated or stainless steel; Max Safe Load: 1500N. Ultimate Tension: 3000N; Size: 140.5mm x 34mm

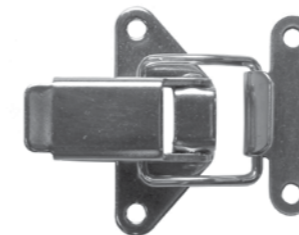

2.04.00

Toggle Latch available in nickel plated or stainless steel; Max Safe Load: 550N. Ultimate Tension: 1500N; Size: 52mm x 28mm

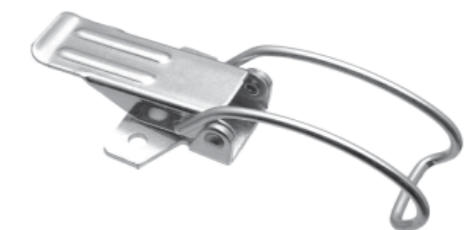

CL621.2.05

Toggle Latch available in zinc plated or stainless steel; Max Safe Load: 200N. Ultimate Tension: 1000N; Size: 125mm x 33mm

Toggle Latches

TOGGLE LATCH



2.07.00
Toggle Latch available in nickel plated or stainless steel; Max Safe Load: 300N. Ultimate Tension: 600N; Size: 81mm x 30mm



2.08.00
Toggle Latch available in nickel plated; Max Safe Load: 500N. Ultimate Tension: 900N; Size: 90mm x 13.5mm



2.43.00
Toggle Latch available in zinc plated; Max Safe Load: 550N. Ultimate Tension: 1000N; Size: 40mm x 15mm

TOGGLE LATCH W/ CLICK ARREST



2.00.40
Toggle Latch available in zinc or nickel plated; with click arrest; Max Safe Load: 2000N. Ultimate Tension: 4000N; Size: 193.5mm x 43mm

TOGGLE LATCH W/ SECONDARY LOCK



2.00.02
Toggle Latch w/ secondary lock; available in nickel plated or stainless steel; Max Safe Load: 2000N; Ultimate Tension: 4000N; Size: 193.5mm x 43mm

Toggle Latches

HASP TOGGLE LATCH



2.00.01
Hasp Toggle Latch available in zinc or nickel plated; Max Safe Load: 2000N. Ultimate Tension: 4000N; Padlockable; Size: 193mm x 43mm



2.01.01
Hasp Toggle Latch available in nickel plated; Max Safe Load: 1500N. Ultimate Tension: 3000N; Padlockable; Size: 140.5mm x 37mm



2.03.01
Hasp Toggle Latch available in nickel plated or stainless steel; Max Safe Load: 550N. Ultimate Tension: 1300N; Padlockable; Size: 102mm x 23mm



2.04.01
Hasp Toggle Latch available in nickel or zinc plated; Max Safe Load: 550N. Ultimate Tension: 1500N; Padlockable; Size: 52mm x 28mm

TOGGLE LATCH W/ TENSION SPRINGS

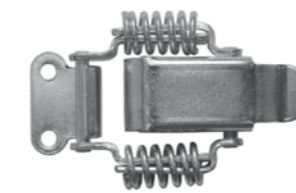

2.42.00
Toggle latch available in zinc plated w/ tension springs; Maximum safe load - 500N. Ultimate Tension - 1500N; Size: 61.5mm X 37mm

TOGGLE LATCH W/ KEY LOCK



2.00.03
Toggle Latch available in zinc plated; Key locking; Max Safe Load: 2000N. Ultimate Tension: 4000N; Size: 193.5mm x 43mm

Toggle Latches

ADJUSTABLE TOGGLE LATCH

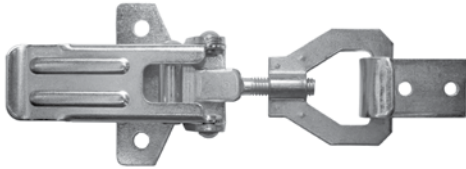

2.05.00

Adj. Toggle Latch available in zinc plated or stainless steel;
Max Safe Load: 1100N.
Ultimate Tension: 2500N;
Size: Length 130 - 150mm x 52mm



2.41.00

Adj. Toggle Latch available in zinc plated; Max Safe Load: 1000N
Ultimate Tension: 1400N;
Size: Length 60 - 70mm x 25.5mm



2.41.01

Adj. Hasp Toggle Latch available in zinc plated or stainless steel; Padlockable;
Max Safe Load: 1000N. Ultimate Tension: 1400N; Padlockable;
Size: Length 60 - 70mm x 25.5mm

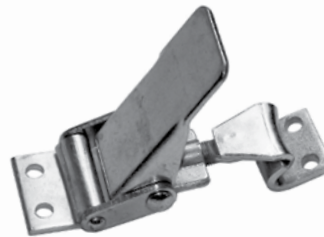

2.46.00

Adj. Toggle Latch available in zinc plated; Max Safe Load: 750N
Ultimate Tension: 1500N;
Size: Length 60 - 65mm x 19mm

ADJUSTABLE OVER-CENTRE LATCHES

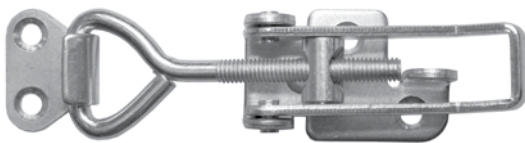

OL412; OL413; OL414

Adj. Over-Centre Latch; available in zinc plated mild steel or stainless steel; Available in sizes:
OL412 Length 83 - 89mm X 23mm;
OL413 Length 105 - 120mm X 31mm;
OL414 Length 145 - 165mm X 40mm

