



LEVIWEIGHT
LIFTING AND ERGONOMIC SOLUTIONS



4000ES



FEATURES:

1. Close Swivel post with maximum torsional rigidity
2. Telescopic cylinders with very long stroke for a maximum hydraulic range
3. Highly resistant base roller bearing, outstanding motion precision, very little friction, no wear.
4. 3 point linkage as required by the leading truck producers.
5. Shaped arm with closed section, max resistance to torsional stress, and light structure.



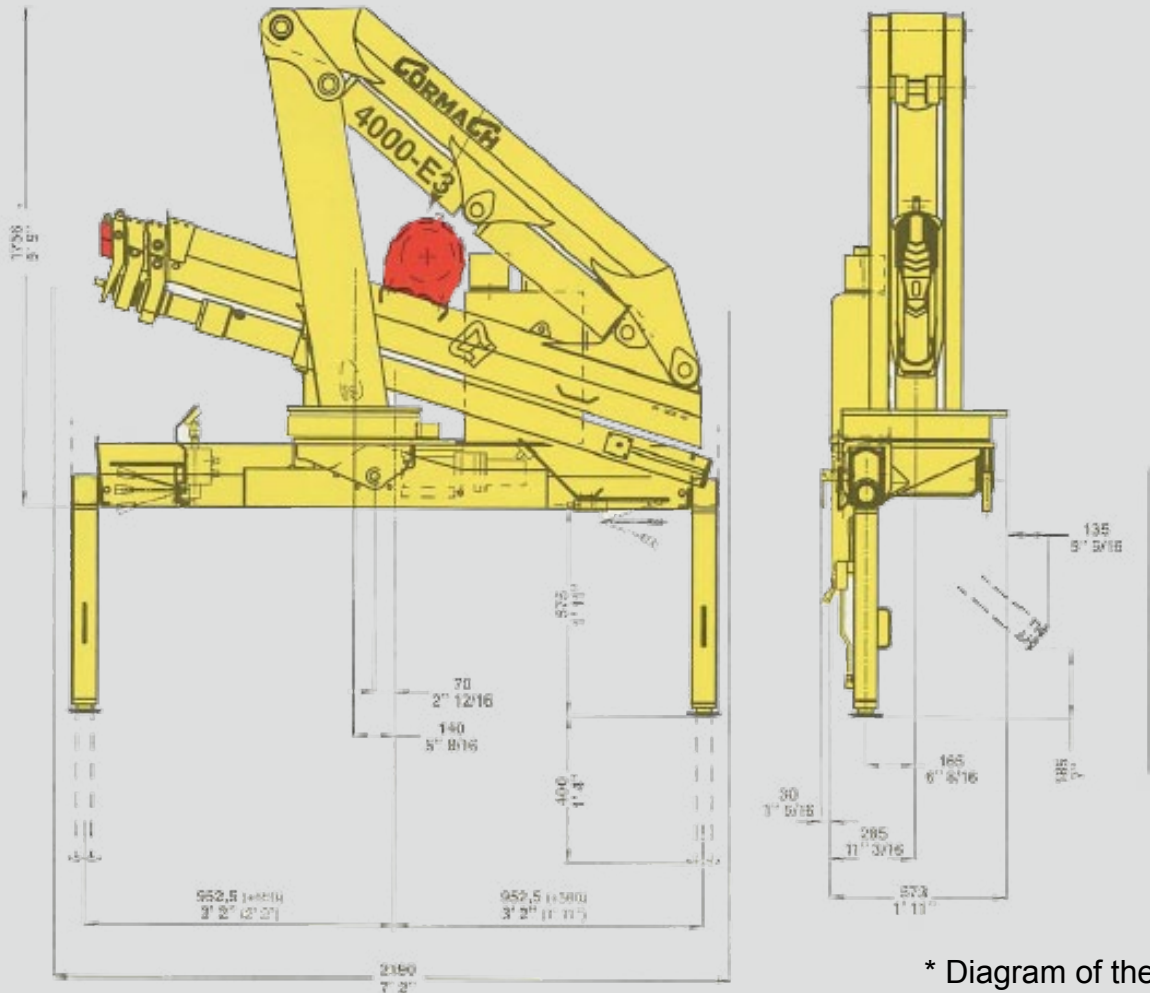

Leviweight offers the complete range of Cormach crane trucks. The 4000 E series is a versatile solution for many industries - construction, waste handling, local government and more.















* Diagram of the 4000 E3

STANDARD

-  Rotation 360 degrees
-  Tilt up outriggers
-  Dual control stations

OPTIONAL

-  Load limiting device
-  Rotation continue
-  Manual extensions
-  Outriggers with hydraulic extension
-  Radio remote control
-  Cable remote control
-  Winch
-  Top sit
-  Additional accessories
-  Additional function
-  Additional outriggers beam
-  Additional outriggers with extension
-  Basket



www.leviweight.com



Ask about our full range!

