



Security Screen Doors & Windows

Fire & Emergency Escape Screens

Kids Fallsafe Screens

Steel Doors

Diamond Grilles

Retractable Flyscreens

Slatted Privacy Screens

Plantation Shutters

Outdoor Blinds & Shutters

Louvre Roofs

[spscreens.com.au](http://spscreens.com.au)



*“We’re passionate about making people feel safe, secure and comfortable in their own homes.”*

SP Screens offer a range of security screens, safety screens and privacy solutions to suit a variety of budgets.

We’re passionate about making people feel safe, secure and comfortable in their own homes. We have local experienced teams along the East Coast from Brisbane to Wollongong, and in Perth, and are continuously expanding to new areas.

Visit [www.spscreens.com.au](http://www.spscreens.com.au) for showroom location details or to book your free consultation online.

We partner with suppliers who provide high quality products, backed by generous warranties, to help you:

- safeguard your family and possessions from would-be intruders,
- keep out unwanted insects,
- maintain privacy,
- provide a barrier against extreme weather, sunlight and noise, and
- create an inviting outdoor entertaining space.

Whatever your individual needs, SP Screens have a solution for your home.



**Book a free in-home consultation**

Our sales representatives will help you choose products to suit your needs



**Custom made**

Each product is custom made to ensure the perfect fit



**Professional installation**

Our local team of experienced installers are licensed to meet Australian Standards 5040 - Installation of security screen doors and window grilles



**Quality guaranteed**

We supply quality products from reputable suppliers backed with generous warranties



**Competitive prices**

We have established strong relationships with Australia’s leading vendors and are able to offer our products at a great price



5

Security Screens:  
Doors



14

Retractable  
Flyscreens



6

Security Screens:  
Windows



16

Plantation  
Shutters



8

Security Screens:  
Mesh Options &  
Colour Range



19

Outdoor  
Roller Blinds



10

Security Screens:  
Comparison Table



20

Louvre Roofs

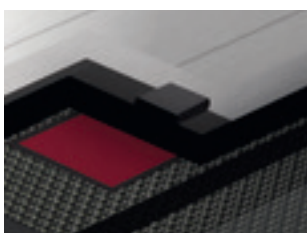

11

Security Screens:  
Design & Testing



21

Outdoor  
Roller Shutters



12

Steel Doors



22

Privacy Screens



13

Diamond Grilles

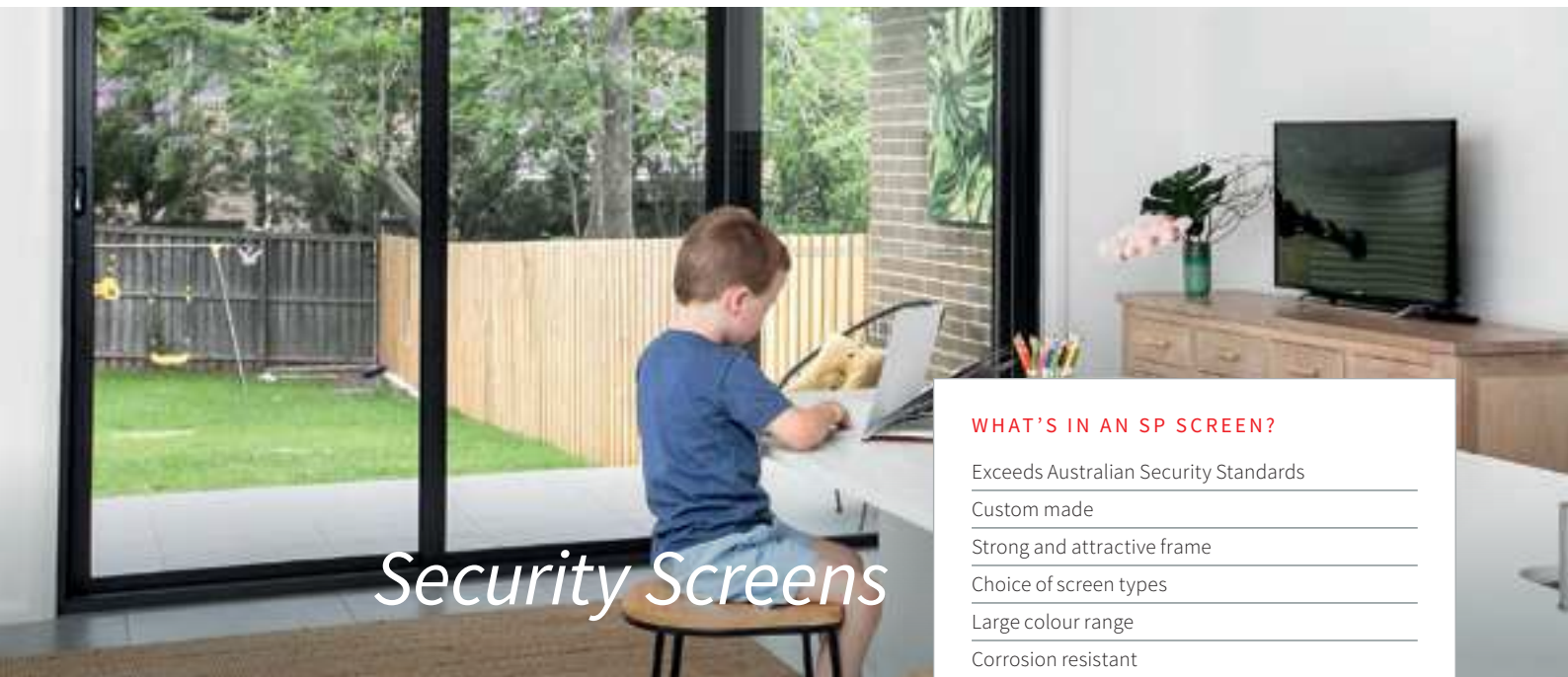

# Security Screens

## WHAT'S IN AN SP SCREEN?

- Exceeds Australian Security Standards
- Custom made
- Strong and attractive frame
- Choice of screen types
- Large colour range
- Corrosion resistant
- Professional licenced installation



Custom Made

Quality security screen doors and windows to suit a variety of homes, security needs and budgets.



Professional Installation

*Our custom built security screens are always on guard*

- Security against intruders
- Keeping children safe from window falls
- Safe emergency exit from house fires
- Protection during cyclones and bushfires



Quality Guaranteed

*Your safety is our priority*

At SP Screens, we are committed to installing high quality security screens for doors and windows that stop intruders in their tracks.

Our security screens are designed for superior strength and safety, and exceed independent testing, ensuring we can protect Australian homes and give families peace of mind.



Competitive Prices\*

*We've got you covered with a wide range of options*

Our security screens are available in:

- Hinged, sliding & stacking security doors
- Fixed, hinged & sliding window security screens
- Fallsafe Screens
- Fire & Emergency Escape Screens
- Cyclone screens
- Bushfire screens
- Pet doors
- Shop fronts
- Outdoor room extensions

With a sleek design, they blend effortlessly into any façade, ensuring they look great in any home.

*Guaranteed to last*

Each SecureView Eclipx and Xceed security screen is custom made in Australia to precise door or window measurements and professionally installed by our local team of licenced installers. These quality products are backed by industry leading warranties.



# Security Screen Doors

Our security screen doors offer peace of mind day and night

Security screen doors are versatile and functional allowing you to vet visitors before you let them in, and secure your doorway while you leave your door open for ventilation.

Our range of hinged and sliding security doors provide safety, security, and peace of mind and are custom made to fit any door style and size.

Designed to complement the aesthetics of each doorway, both SecureView Eclipx and Xceed security screens let you incorporate an exceptional level of security into modern designs providing you with safety and style.

Our security screen doors are manufactured using a patented tensioning tool which enables our screens to be custom built for most large openings without mid rails.

## FEATURES

Complies with Australian Security Standards

Custom built in Australia to precise measurements

Suitable for out of square doorways

Highly tensioned mesh

No mid rails obstructing your view



Hinged door



French door

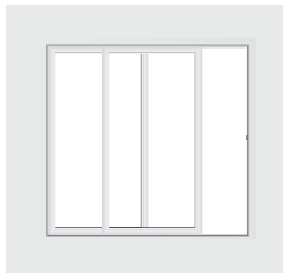

Sliding door

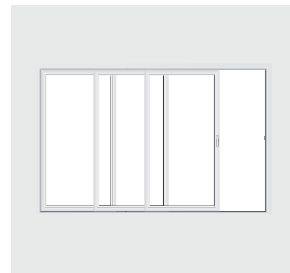

Stacking door (double and triple)



# Window Security Screens

Window safety and security from the inside out.

Our durable security screens allow you to get the most out of passive cooling, by making it safe to open every window to its full extent – and keep it open – without interrupting your view.

We can protect windows of all sizes with either SecureView Eclix or Xceed security screens.

Our security screen windows are manufactured using a patented tensioning tool which enables our screens to be custom built for large openings with reduced flex.

## FEATURES

Complies with Australian Security Standards

Custom built in Australia to precise measurements

Suitable for out of square windows

Meets Building Code

Our fixed, hinged and sliding security screens suit a range of window styles including:



Sliding (single & double)



Single and double hung

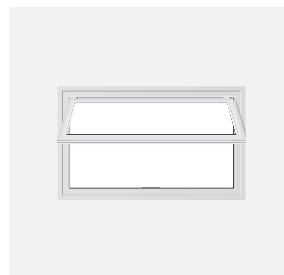

Awning



Casement



### *Kids Fallsafe Screens*

- No need for a window lock restricting the opening to 12.5cm
- Meets Building Code legislation
- Complies with Australian Security Standards (AS 5039-2008)

Kids Fallsafe Screens are a great choice for bedrooms and high traffic areas where you would like to fully open your window while kids play.

The Building Code of Australia (BCA) set legislation that windows 2 metres above the ground floor cannot open more than 12.5cm unless the opening is protected to withhold 25kg of pressure in three different points. Flyscreens do not comply with this code.

When installed by our licenced installers, the SecureView Eclix and Xceed Security Screens comply with the BCA code, and we can conduct testing to certify your Kids Fallsafe screen.

Both screens have been independently tested to comply with Australian Security Standards.

#### **DID YOU KNOW...?**

Most window accidents happen in the family home due to kids playing, climbing, or jumping near open windows and leaning on fly screens.

### *Fire & Emergency Escape Screens*

- Quick and keyless opening from the inside
- Exceptional external security
- Complies with Australian Security Standards
- Optional outward swinging, inward winging, and sliding

It is important to determine an emergency escape option, particularly when you are screening your entire home. Fire & Emergency Escape Screens feature a keyless, quick release latch, for easy opening in case of an emergency, without compromising on external security.

These exceptionally strong screens were innovatively designed with safety and practicality in mind. Fire & Emergency Escape Screens are available in outward swinging, inward swinging, and sliding options.



## Choose the right security screen product for you

Our range of security screen systems include our top of the range SecureView Eclipx stainless steel security screens and our economical Xceed perforated aluminium screens.

Both offer a wide range of features to meet Australian Standards AS5039-2008, while SecureView Eclipx meets additional testing to ensure it continues to protect homes in cyclone, fire and corrosion prone areas.



SecureView Eclipx security mesh is made from .8mm 316 marine grade stainless steel, expertly woven in state-of-the-art facilities, and extruded aluminium frame using a patented fixing method.

Superior to its 304 steel counterpart, SecureView Eclipx is selected for its superb strength, durability and resistance to corrosion, embers and flying debris.

With a thin, impenetrable mesh, SecureView Eclipx gives you ultimate security, clear unobstructed views, without compromising on the aesthetics of your building.

### Features

- Surpasses Australian Standards
- Corrosion resistant – 316 marine grade woven mesh
- Cyclone rated
- Bush fire rated
- Highly tensioned mesh
- Unobstructed views





### Colour range

Select from our range of 28 colours including wood effect, or we can custom match the colour of your choice

Xceed security screens are made from an extremely durable perforated aluminium sheet and extruded aluminium frame using a patented fixing method. Perforated aluminium screens are a modern and more secure replacement for dated Diamond Grilles and a less expensive alternative to the premium woven stainless steel mesh.

Xceed is a great cost effective alternative to woven mesh security screens. They offer a wide range of features to meet Australian Standards, has the corrosion resistant properties of aluminium, and act as a sun shade to reduce heat.

Due to its structural grade alloy, the Xceed perforated aluminium is thinner and stronger than the commonly used architectural grade aluminium.

### Features

- Surpasses Australian Standards
- Corrosion resistant properties of aluminium
- Added privacy





ANODIC NATURAL MATT	ANOTEC DARK GREY	APO GREY	CHARCOAL
CUSTOM BLACK	DEEP OCEAN	DUNE	HAMMERSLEY BROWN
JASPER	MONUMENT	PALLADIUM SILVER	PAPERBARK
PEARL WHITE	PRIMROSE	STONE BEIGE	SURFMIST
ULTRA SILVER	WHITE BIRCH	WOODLAND GREY	ANOTEC SILVER GREY
BRONZE ANODISED	CHAMPAGNE	CLEAR ANODISED	HAWTHORN GREEN
NOTRE DAME	POTTERY	SHALE GREY	WESTERN RED CEDAR (WOOD EFFECT)

**Note:** All colours above are available however the standard colour range varies by product. These colours are for reference only and are an approximate of the true colours.

View our colour range online

To view our online colour visualiser, visit [www.spscreens.com.au/colour-range](http://www.spscreens.com.au/colour-range)

SecureView and Xceed features at a glance

	Premium security	Economical security	Not security
			Compared to barrier screens
<b>Features</b>			
Mesh infill	High tensile, corrosion resistant, 316 marine-grade stainless steel 	Corrosion resistant perforated, structural grade aluminium panels 	EG Diamond Patterned Grille
3 Point Locking System	Yes	Yes	Optional
Patented Fixing System	Yes	Yes	No
Mesh Thickness	.8mm	1.6mm	N/A
Airflow	Excellent	Excellent	Good
Hole Aperture	1.575mm	2.20mm	Variable
Insect Protection	Excellent	Great	Good until flyscreen tears
Attractive, Sleek Look	Excellent	Great	Unattractive
Pet door options available	Yes	Yes	Yes
Manufacturer's Warranty	11 years	7 years	Typically none
<b>Testing</b>			
Security Grade Australian Standard (AS5039)	Yes	Yes, when fitted with a 3 Point locking system	Typically poor and not tested
Aluminium Frame Tests	Pass	Pass	Untested
Cyclone Screen Test	Pass	Untested	Untested
Fire Rated	Pass	Untested	Untested
10,000 Hour Salt Spray Tests	Pass	Untested	N/A
Stainless Mesh Tests	Pass	Untested	N/A

Mesh samples can be supplied during your free consultation or by visiting your local showroom.



**FEATURES**

- Strong and attractive frame
- Mesh and frame is bonded with VHB closed cell technology
- No screws or rivets

# Designed for strength and durability with a sleek finish

## Testing: How strong is it?

The Australian Standards (AS5039 – 2008) stipulate a range of scientific tests that a security product must pass in order to remain in this class. These tests ensure the intrinsic strength and structural integrity of our manufactured security doors and windows are maintained. Both SecureView and Xceed are frequently independently tested and consistently surpass these standards.

### Australian Standards (AS5039 – 2008)

- Knife Shear Test
- Pull Test
- Anti-Jemmy Test
- Impact Test
- Probe Test\*
- Shear test\*

\*NA due to the hole aperture being far less than the test requirement

## SecureView Eclix security screens surpass additional testing to achieve:

### Aluminium Frame Tests

(AS/NZS1866:1997 & AS3715 – 2002) 60603 T5 powder-coated to a minimum thickness of 60um

### 10,000 Hour Salt Spray Tests

AAMA2605-05 Section 7.8.2

### Stainless Mesh Tests

AS3175-2002, AAMA2603-05, AAMA2605-05, AS2331/ISO2360, ASTM D2794, AS3715, ISO1519, JIS Z2241, ASTM E1086

### Bush Fire Protection

AS3959-2009 satisfying the requirements for bushfire attack level (BAL) 12.5,19,29,40.

### Fire Attenuation Test

Australian Standard AS1530.4-2005, Appendix B7 achieving 45.6% reduction in radiant heat flux between the inside and outside of the product.

### Cyclonic Screen Test

Australian Standard 2010: AS1170.2-2011 resisting a 4kg, 100mm x 50mm timber projectile travelling at 30 metres per second (108 kph) surpassing the standard test of 15 metres per second.

Further information on each of these Australian Standards tests are available through our supplier at [www.commandex.com.au](http://www.commandex.com.au).

## Design: How is it put together?

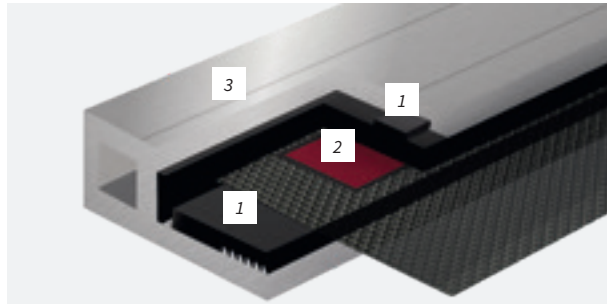

### Patented fixing system

Both our SecureView Eclix and Xceed Security Screens use a unique Australian Patented fixing method that maintains unsurpassed strength and durability.

#### 1 – Innovative keyway fixing system

The unique two-part wedge system has been designed to create the precise pressure required to activate the VHB™ adhesive to its full potential. This VHB™ chemical bonding is proven to have the strength to replace rivets. Both wedges are made from UV stabilised PVC to yield superior durability over time.

Unlike screw-clamp or riveted systems, all our screens use innovative technology that provides clear spacing between the security screen infill and aluminium frame. This eliminates the opportunity for galvanic corrosion, which occurs when dissimilar metals contact.

#### 2 – 3M™ VHB™ acrylic bonding

All our security screens are free from mechanical fixings such as screws and rivets. Instead they employ VHB high performance chemical bonding technology to create effortless strength.

The acrylic chemistry of the VHB adhesive delivers exceptional durability while its viscoelasticity provides superior energy absorbing properties which helps to eliminate stress points.

#### 3 – Sleek aluminium frame

Our extruded aluminium frame system is crafted to deliver a lightweight solution without compromising on strength. The frame features gold accredited Interpon™ powder coating that delivers a durable finish in a versatile range of colours including the latest Colorbond™ colours.

Solid aluminium stakes are used to fortify each corner join, providing both SecureView Eclix and Xceed screens with steadfast strength.

#### Three-point locking system

As a statement of strength, our security screen doors are characterised by our integrated three-point locking system as standard.

# Steel Doors

Steel doors allow you to add your own personal style to your home. And at SP Screens we specialise in the supply of federation and colonial style steel doors which are built to last.

These traditional, ornate doors not only give an authentic nod to the past, but they are made with superior toughness and durability; providing you with reassurance.

### *Make a big statement in your home*

At SP Screens we have a range of designs and colours available, and we can easily custom make your steel door to match your individuality.

With over 30 Designs to choose from, speak to your local SP Screens Sales Representative for advice on choosing the right design for you.

#### KEY FEATURES AT A GLANCE

Powder coated to your choice of colour

Viro latch and deadlock

Door fitted within a steel frame

Fully welded heavy duty hinges

Internal - 12 x 12mm solid steel bar

Charcoal fibreglass fly mesh

Quality brass scroll handles

5 lever mortice lock

Anti-jemmy cover plate

Tubular Frame 25 x 25 x 2.5mm RHS steel

All work hot dipped galvanised

Some popular designs include:



Custom Made



Professional Installation



Quality Guaranteed



Competitive Prices

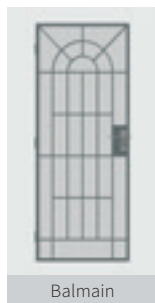

Balmain

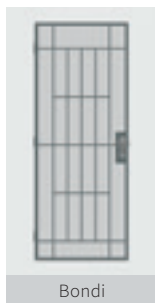

Bondi

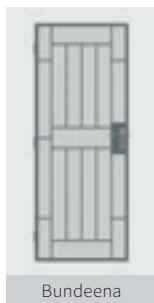

Bundeena

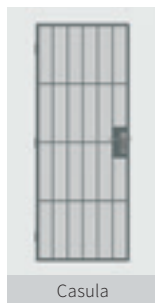

Casula

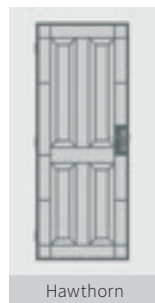

Hawthorn

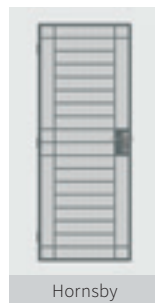

Hornsby

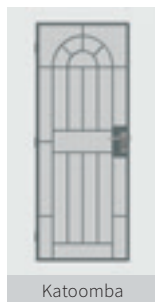

Katoomba

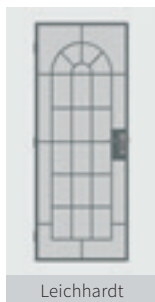

Leichhardt

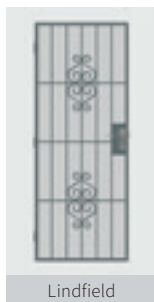

Lindfield

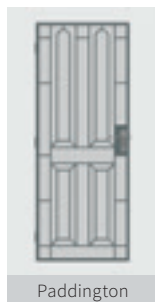

Paddington



Rosehill

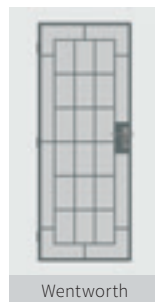

Wentworth

All designs shown are available in door and window grilles.



## Diamond Grilles

A great entry point for reliable home safety. Diamond Grille's strength comes from its distinctive diamond mesh pattern. Made from 7mm aluminium, the grille is pressed into an aluminium frame and then finished with a flyscreen insert.

### *Keeps more than just bugs out*

For added strength, the grille is riveted at regular spacing around the entire frame. The end result is a safety door that not only keeps bugs out, but deters unwanted intruders too.

### *Economical and reliable at the same time*

The popularity of Diamond Grille safety screens is largely due to their cost effectiveness. Considering its impressive performance, it's a great value option that has been proven to be an excellent home security solution when fitted with a triple lock.

### *Available in many colours, shapes and sizes*

Our Diamond Grille Safety Screens come in a variety of mesh finishes and full colour range to match your décor. They also come in a wide range of applications to perfectly suit your requirements, including:

- Single-hinged doors
- Double-hinged doors
- Single sliding doors
- Double sliding doors
- Multi-stacking sliding doors
- Fixed window grilles



Custom Made



Professional Installation



Quality Guaranteed



Competitive Prices



# Retractable and Pleated Flyscreens



Custom Made



Professional Installation



Quality Guaranteed



Competitive Prices

We offer a range of screening solutions to accommodate wide or tricky spaces. Our durable and stylish retractable and pleated insect screens are designed to integrate seamlessly with your home.

## *Setting the standard in retractable and pleated insect screens*

These screens are a real favourite among Australian homes that have Bi-fold doors, French doors, Stacker doors, Pivot doors, Awning windows and Casement windows. Our retractable and pleated insect screens use a superior design system combined with an extra strong, durable mesh that ensures they are engineered to last.

### *Pick the system that works best for you*

#### **Retractable System**

A system that allows you to roll the screen out when you need it, and roll it away when you don't. It will gently retract into the cassette which blends seamlessly with your windows and/or door frames.

Retractable insect screens come with a 7-year warranty and are available as either a standard soft close system or a multi-lock system.

The multi-lock soft close system enables the screen to be fixed part way along the screen opening so it can be left partially open. Perfect for when you wish to create a small opening for people and pets to go in and out.

#### **Pleated Insect Screens**

A pleated screen works in the same way as a concertina: by using the folds to neatly stack the mesh back into itself. When the screen is extended, a series of tensioning cords keep the mesh in position. Pleated Insect Screens can span up to an impressive nine metres with a double screen, and four and a half metres for a single screen.

### *Affordable and easy to maintain*

Retractable and Pleated Insect Screen Systems are not only affordable, but super easy to maintain as the components and mechanisms can be accessed with no difficulty at all. This ensures you can clean and service your screens, keeping them in great condition for longer.



### Choose from a range of styles and sizes

Retractable and Pleated Insect Screens can be fitted in a variety of different sizes to cater for the many different sizes and styles of home doors and windows.

Our retractable screens range from extra small (suitable for screens up to 650mm) to extra large (suitable for screens up to 3200mm). Pleated screens can be fitted to slide up or slide across and can be fitted to screen large areas.

### In a colour that's as individual as you are

Retractable and Pleated Insect Screens are available in a range of standard colours. If you require a special colour, we have a range of finishes that are available on request. Simply choose from the Dulux® or Interpon® powder coating charts.

Standard colours available for all systems include:

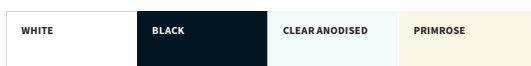

### Insect screens

A range of frame colours are available with a choice of three types of insect mesh:

- Bushfire Approved Mesh – A stronger option mesh for any job
- Pet Proof Mesh – Scratch-resistant and tougher than standard fibreglass
- Fibreglass Mesh – The standard for most flyscreens

Insect screens for window and doors are manufactured to suit a range of styles including:

- Single & double hinged doors
- Single & double sliding doors
- Multi stacking sliding doors
- Window screens

### Unsure which screen is right for your home?

Our experienced Sales Representatives can advise on the best screen for your property.



Custom Made



Professional Installation



Quality Guaranteed



Competitive Prices



Custom Made



Energy Efficiency



Professional Installation



Quality Guaranteed



Competitive Prices

## Plantation Shutters

SP Screens custom made plantation shutters are constructed from the highest quality materials and are available in a wide range of colours and timber stains.

### *Privacy with style*

Choose from Paulownia Timber, Basswood, or Fauxwood plantation shutters in a range of styles such as bi-fold, sliding, fixed or hinged.

The elliptical blades can be operated with ease by hand and adjusted for optimal privacy and energy efficiency. Save on heating and cooling costs with our quality custom made plantation shutters.





### Types of Plantation Shutters

**PAULOWNIA TIMBER**

(5 year materials and construction warranty, 3 year paint warranty\*)

Moderately water resistant

Light weight

Superior thermal qualities

Termite and rot resistant

Range of colours and timber stains to choose from

5 layers of polyurethane paint

**BASSWOOD**

(5 year materials and construction warranty, 3 year paint warranty\*)

Light weight hardwood

Low thermal conductivity

Not recommended for wet areas

Range of colours and timber stains to choose from

5 layers of polyurethane paint

**FAUXWOOD**

(20 year materials and construction warranty, 3 year paint warranty\*)

Water resistant (ideal for all wet areas)

Superior thermal qualities

Termite and rot resistant

Range of colours to choose from

2 layers of polyurethane paint

\*Terms and conditions apply



**Wide range of colours and timber stains**

Select from our range of on trend colours and natural timber stains. Our plantation shutters are painted or stained after manufacture for a smoother, more durable finish. Each finish is guaranteed for 3 years.

**Fauxwood Paint Colours:**

PURE WHITE	WHITE CLOAK QTR	STAR WHITE	WITCH HAZEL
LOVE NOTE	SOLAR FLIGHT	ANTIQUE WHITE	JASPER

**Paulownia Timber and Basswood Colours and Stains:**

PURE WHITE	WHITE CLOAK QTR	STAR WHITE	WITCH HAZEL
LOVE NOTE	SOLAR FLIGHT	ANTIQUE WHITE	JASPER
MONUMENT	SILHOUETTE	BLACK	

**Stains:**

NATURAL	GOLDEN OAK	CORDOVAN	WALNUT
---------	------------	----------	--------

**Design options**

**Shape**

Our plantation shutters are custom made to suit any shape window.

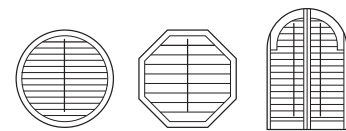

**Mounting Method**

Fixed, hinged, sliding and bi-fold options are available. Inside mount or outside mount as determined by the window style.

**Blade Size**

63mm, 89mm, 114mm

**Midrail Height**

Panels greater than 1800mm in height will require a midrail.

**Tilt Rod**

Hidden tilt rod, centre tilt rod and offset tilt rod options available for both PVC and timber shutters as standard.



# Outdoor Roller Blinds

A stylish solution to add privacy and protection from the weather.

Whether you're looking to create an outdoor room or create privacy and protection from the sun, wind, and rain, our custom made outdoor roller blinds offer a stylish and practical solution.

Our outdoor blinds incorporate style and durability, and are available in a wide range of colours to compliment the aesthetics of your outdoor area. Professionally installed by our expert installers, they are ideal for residential alfresco areas, verandah's and patios.

## *Australian made and designed for Australian conditions*

Our outdoor blinds are manufactured from corrosion resistant heavy duty components and feature Visiontex fabric set in wind resistant restrained tracks on both sides.

### *Technical specifications*

<i>Max Width</i>	6600mm
<i>Max Area</i>	21m <sup>2</sup>
<i>Standard Track Dimensions</i>	50 x32mm
<i>Bottom Bar Size (Heavy Duty)</i>	62mm
<i>Standard Axle (Heavy Duty)</i>	84mm circular

Solar powered and battery operated with remote control

View our colour range online

[www.spscreens.com.au/colour-range](http://www.spscreens.com.au/colour-range)



Custom Made



Professional Installation



Energy Efficiency



Quality Guaranteed



Competitive Prices



# Louvre Roofs



Custom Made



Professional Installation



Energy Efficiency



All Season



Quality Guaranteed



Competitive Prices

Increase undercover space and add value to your home.

## *Control your outdoor living environment at the touch of a button*

Create an all-season patio with our electronic opening louvre roof. Fully open to let the light and sun in, close to shade and protect from the rain, or partially open and direct the louvres towards or away from the sun to optimise energy efficiency in your home.

Our louvre roofs are engineered for quality and style, and backed by a 10 year warranty. Each roof is custom made using aluminium with stainless steel fixing to provide optimal rust resistance.

View our colour range online  
[www.spscreens.com.au/colour-range](http://www.spscreens.com.au/colour-range)

## Roofing system configurations

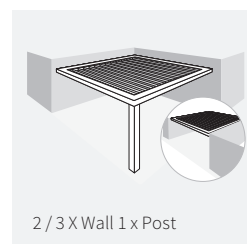
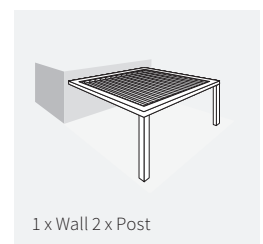

### TECHNICAL SPECIFICATIONS

Material: Extruded Aluminium, Stainless Steel fixings

Operation: Motorised

Motor Type: 240 V DC Lineal Actuator

Blade Rotation: 130 Degrees

Max Blade Span: 5000mm Max

Beam Span between Post: 6000mm

Max Area per Motor: 16m<sup>2</sup>

Blade size: 210mm x 44.5mm



# Outdoor Roller Shutters

Feel secure and control the light, heat and noise in your home.

## Save up to 40% on heating and cooling energy costs

Each panel of our insulated solar powered roller shutters are injected with polyurethane foam for increased strength and insulation so you control the light, heat and noise entering your home.

With a range of colours and slimline mounting options available, the shutters are designed to integrate with your buildings colour scheme, and improve your privacy and security.

View our colour range online  
[www.spscreens.com.au/colour-range](http://www.spscreens.com.au/colour-range)

## Technical specifications

**Colour Range** 11 profile standard colours | 8 head box standard colours

**Insulation** Aluminium panels are injected with polyurethane foam for increased strength and insulation

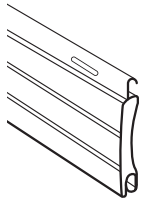
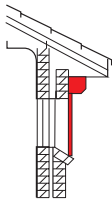
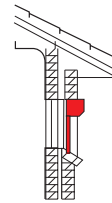
Slat profile:	Mounting Options:	
Curved	Face fit	Reveal fit
		

**Security** Act as a visible deterrent

**Warranty** 5 years

**Motor** Solar powered and battery operated with remote control



Custom Made



Professional Installation



Energy Efficiency



Quality Guaranteed



Competitive Prices



# Slatted Privacy Screens



Custom Made



Professional Installation



Energy Efficiency



Quality Guaranteed



Competitive Prices

Add privacy to your home and yard with our customisable privacy screens.

A sleek customisable aluminium slat system that can be installed as a screen, fence or gate in your yard to provide privacy for your home by screening your family from the street or the neighbours.

Our professional installations offer a compelling alternative to wasting your weekends on DIY projects. Forget visiting the hardware store for flimsy, ill-fitting, inferior aluminium slatted screens that take days to install.

Our professional team can help you choose the privacy screen or gate that's perfect for your home and ensure a solid, beautiful result without you lifting a finger. Offering the flexibility to choose almost any colour and size at whatever slat spacing you choose with a sleek design which cleverly hides all ugly screws from sight.

*Aluminium slatted screens can be used to provide privacy and cover for a range of scenarios around the home:*

- **Brick pier infills**  
Ideal for pier infills adding modern style and privacy.
- **Fencing and gates**  
To keep your home and/or pool area safe and secure.
- **Deck and/or balcony areas**  
So you can relax and enjoy complete privacy when you're outside.
- **Utility screens**  
Including pool filter boxes, bins, air conditioning units and/or gas bottles.
- **Screening in carports and patio enclosures**  
Providing extra screening and privacy.
- **Window screens**  
Giving you privacy from neighbouring houses and the sun



### *Designed for impact and built to last:*

- Professional installation
- Engineered and constructed to stand the test of time.
- Reinforced screwed fixings – Keeping your screen super secure, long-lasting and withstanding of the elements.
- 11-year warranty
- Superior Quality Accessories – We only use the highest quality hinges, latches and locks from reputable suppliers on all our privacy screens and gates.

### *Customise your privacy screen*

The slatted aluminium panels are fully customisable, so you can specify the privacy screen height, width, and slat spacing.

### *Technical specifications*

---

*Slats:* 65mm x 16mm

---

*Privacy screen posts:* 44mm x 44mm

---

*Gate frame & posts:* 50mm x 50mm

---

*Slat spacing:* fully customisable

---

Mounting location and panel size will determine if a mid rail or centre post is required.

---



For showroom location details or to book your free consultation online visit:

[spscreens.com.au](https://spscreens.com.au)

You'll have a choice of days and times and we'll contact you to confirm your booking.

**1300 939 700**

[salesupport@spscreens.com.au](mailto:salesupport@spscreens.com.au)



Your local representative:

\*Product range may vary based on location.