

FENCING MANUAL

speedrite™
by TRU-TEST®



ELECTRIC FENCING FOR THE SERIOUS FARMER

Contents

Tru-Test electric fencing	1
How an electric fence works	1
Benefits of electric fencing	1
What type of fence do you need?	2
Permanent fence.....	3
Planning the fence layout	3
Choosing an energizer.....	6
Installing an energizer	7
Installing an earthing system	8
Leadout from the energizer	12
Fence posts	13
Strainer assemblies	15
Wire	17
Fence connections	18
Gates	18
Lightning protection.....	20
Flood gates	21
Electrifying a conventional fence	22
Subdividing the fence.....	22
Temporary fence.....	23
Post and wire spacings	23
Choosing an energizer.....	23
Installing an energizer	24
Strip grazing installations	25
Fault finding	26
Finding faults using a digital fault finder or digital voltmeter	26
Troubleshooting flow chart	27
Telecommunications interference	28

© Tru-Test Limited, 1999-2006. All rights reserved.

Tru-Test is a trademark of Tru-Test Corporation Limited.

No part of this publication may be photocopied, reproduced, stored in a retrieval system, or transmitted in any form or by any means, electronic, mechanical, photocopying, recording or otherwise without the prior written permission of Tru-Test Limited. Product specifications may change without prior notice.

For more information about the Tru-Test range of quality products, see www.tru-test.com.

Tru-Test Limited
25 Carbine Road
Mt Wellington
Auckland 1006
New Zealand

Postal address:
P O Box 51078
Pakuranga
Auckland 1730
New Zealand

Tru-Test electric fencing

Tru-Test is a leading manufacturer of electric fencing supplies, committed to producing quality equipment and systems.

We have created this manual to help you get the most from your electric fences and the best from your land.

Although there are many ways to construct an electric fence, we have outlined some of the most simple and effective methods here. For more information, see your Tru-Test distributor.

How an electric fence works

An electric fence energizer takes electric energy from a power source and delivers it to an electric fence as a pulse. When an animal touches the electric fence it receives a shock.

An electric fence acts as a psychological barrier rather than a physical barrier.

Benefits of electric fencing

Electric fencing provides these benefits:

- Cost effective, requiring less labour and materials than conventional fencing.
- Easy to construct using light materials.
- Animals less likely to be injured if they breach an electric fence. Electric fences protect valuable livestock.
- Flexible - wire spacings and fence designs can be modified to control a variety of animals.
- Increases production by making it easier to subdivide paddocks.
- Fence less prone to damage because animals can't lean on the fence.
- Fence life can be extended by attaching electrified offsets (outriggers) to existing conventional fences.
- Discourages trespassers and predators.
- Environmentally friendly - quick, easy and inexpensive to fence off trees and waterways.

What type of fence do you need?

When planning your electric fencing project, consider what type of fence you need - a permanent fence or a temporary, portable fence.

The type of fence you choose will depend on many factors:

	<u>Temporary, portable fence</u>	<u>Permanent fence</u>
Best suited to	Managed intensive grazing Strip-grazing	Permanent perimeter installations
Expected fence life	Short term	20-40 years
Ease of installation	Simple Fast	Some knowledge and special tools are required.
Animals controlled	Dairy cattle Cattle Horses Sheep	Feral animals/predators Cattle Horses Sheep Goats Pigs Exotic animals and wildlife Deer
Distance	Short distances	Unlimited distances

Permanent fence

Planning the fence layout

Planning the layout of your electric fence will help reduce the amount of time you need to spend checking and maintaining the fence in the future. You will need to consider:

- the geography of your farm
- the type of animals being controlled
- the location of your power supply (if using a mains/line powered energizer)

The fencing plan

Here is an example of a layout for a flat, rectangular farm. The same principles can be applied to hill farms or farms of a different shape.

A lane, race or roadway down the centre or alongside the paddocks can be useful so that animals can be easily moved and checked. If necessary, water pipes can be laid down in this area.

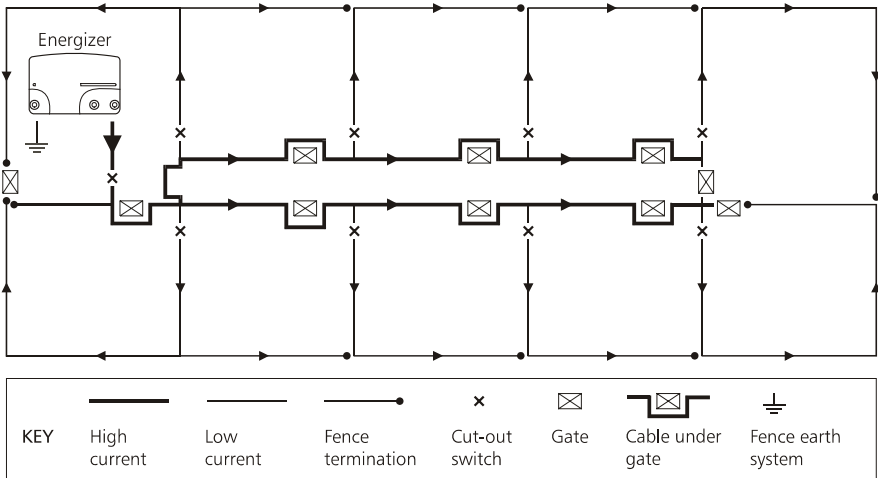

It is important to consider how the fencing plan will affect telecommunications. Avoid a long leadout running adjacent to telephone lines. If this is unavoidable, feed the power to the fence in a 'star' fashion with no closed loops. This will ensure low currents in the sections of fence that are in close proximity to telephone lines. See *Telecommunications interference* on page 27.

Energizer location

The best site for an energizer is at the hub of a number of radiating fences. This minimizes the length of each fence connected to the energizer, reducing the amount of voltage lost along the fence.

Shape of paddocks

Where possible, use square paddocks. Square paddocks utilize space better, allow for more even grazing and reduce the amount of walking required by animals. Long, narrow paddocks are often over-grazed at the front and under-grazed at the back so this shape should be avoided.

In hill country, fence to the contour so that flat areas, sunny slopes and shady slopes are all separate.

Number of paddocks

A farm should have enough paddocks to allow controlled grazing, conservation of hay and silage and long rotations during periods of slow growth. For more information about the number of paddocks required, refer to farm management software or talk to a fencing contractor.

Sheep	You need enough paddocks to enable sheep to be moved daily on to a fresh paddock with up to a 3 month rotation during slow or zero growth periods. In lambing season, two or more flocks can be grazed on a faster rotation.
Dairy cows and beef cattle	When longer rotations are necessary during periods of slow growth, cattle can easily be strip-grazed with only one or two wires.
Horses and deer	Be sure to provide enough room for horses and deer to run around in.

Fence length

This diagram shows the length of fence required to enclose fields of different sizes. To calculate how much wire you need, multiply the length by the number of fence wires. See *Post and wire spacings* on page 4.

AREA GUIDE Length of fence required to enclose fields of different sizes

800 m (½ mile) or 160 posts	800 m (½ mile) or 160 posts	
	1 ha = 2½ acres 1 km = 5/8 mile 1 post = 5 m (16')	
	65 ha (160 acres) Requires 3.2 km (2 miles) or 640 posts of fence to enclose	
	800 m (½ mile) or 160 posts	
400 m (¼ mile) or 80 posts	800 m (½ mile) or 160 posts	
	32.5 ha (80 acres) Requires 2.4 km (1½ miles) or 480 posts of fence to enclose	
	400 m (¼ mile) or 80 posts	400 m (¼ mile) or 80 posts
400 m (¼ mile) or 80 posts	200 m or 40 posts	8.1 ha (20 acres) Requires 1.2 km (¾ mile) or 240 posts of fence to enclose
		16.2 ha (40 acres) Requires 1.6 km (1 mile) or 320 posts of fence to enclose
	4 ha (10 acres) 800 m (½ mile) or 160 posts of fence	2 ha (5 acres) 100 m
	1 ha	(2½ acres)

Post and wire spacings

Here are some suggested post and wire spacings.

Most of the fences below can have an 'all live' or 'earth wire return' system of earthing. See *Installing an earthing system* on page 7.

Fibreglass droppers or battens can be used in between fence posts to hold the fence wires in place. These allow you to space the fence posts further apart. This reduces the number of fence posts required, lowering your overall costs.

Posts only

Posts with droppers or battens

4 Wire feral

5-10 m spacing, posts only

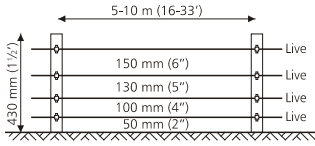

15-20 m spacing with droppers or battens

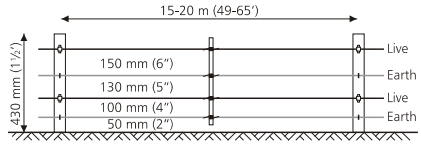

Cattle and horses

10 m spacing, posts only

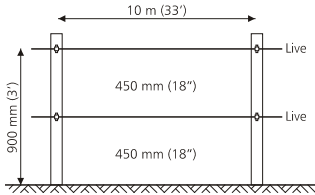

15-20 m spacing with droppers or battens

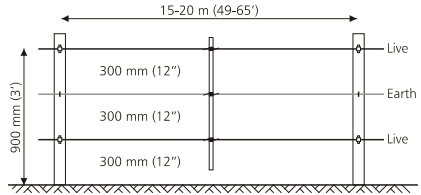

Sheep

10 m spacing, posts only

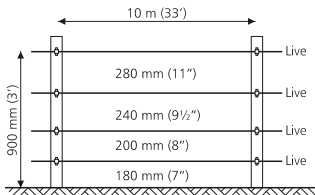

15 m spacing with droppers or battens

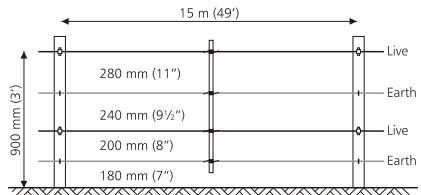

Goats and sheep

10 m spacing, posts only

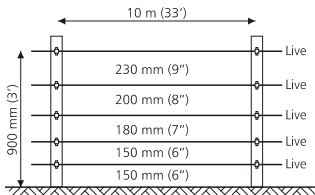

15 m spacing with droppers or battens

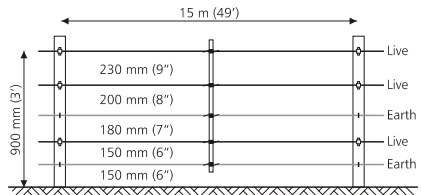

6 wire boundary or subdivision

10 m spacing, posts only

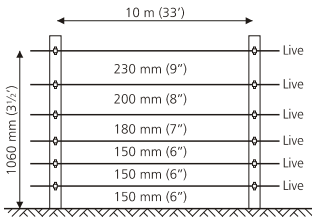

15 m spacing with droppers or battens

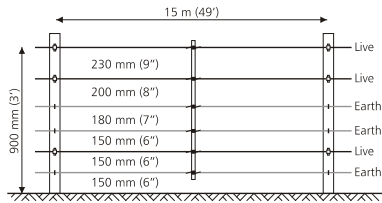

7 wire boundary

5-10 m maximum, posts only

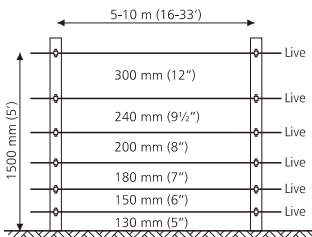

7 wire feral

10 m spacing with droppers or battens

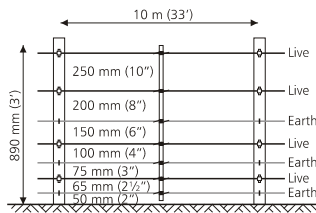

Choosing an energizer

How will you power your electric fence?

- Mains/line** A mains/line powered energizer is the most cost-effective, reliable way to power a permanent electric fence.
- Battery** High powered battery energizers can be used to power multi-wire, permanent fences. Some battery energizers can be fitted with a battery charger power pack, connected to the energizer to the mains/line power. During a power outage the energizer's battery provides back-up power.
- Solar** A solar installation is ideal for isolated areas and fence lines where no mains/line power is available.
Most battery powered energizers can be fitted with one or more solar panels. Self-contained solar energizers have a built-in solar panel.

Comparing energizers

When evaluating energizers, be sure to compare them on the same basis.

- Output energy** the amount of energy that is delivered to the fence.
- Stored energy** the amount of energy stored inside the energizer. This does not necessarily relate to the amount of energy that is delivered to the fence.

It is best to compare energizers by looking at the maximum output energy.

How much fence can the energizer power?

1 joule of output energy will power approximately 10 km (6 miles) of fence wire. This will depend on the type of fence, the number of wires, climatic conditions, amount of vegetation surrounding the fence etc.

Using more than one energizer

Sometimes, dividing the fence line up into separate sections and using one energizer for each fence line may be preferable to connecting all the fence lines to one energizer. This gives more options for animal control and gives greater flexibility in farm management.

Warning! There should never be more than one energizer connected to the same fence line.

Installing an energizer

Before installing the energizer make sure you have read all the instructions provided with your energizer.

Inside installation (mains or battery powered energizer)

- Mount out of reach of children and animals.
- Mount a mains/line powered energizer near a power point.
- If possible, position the energizer in the middle of the fence.

Outside installation (battery powered energizer)

- Mount out of reach of children and animals.
- If necessary, build a protective box or fence around the energizer.
- If possible, position the energizer in the middle of the fence

Outside installation (solar powered energizers)

- Mount out of reach of children and animals.
- If necessary, build a protective fence around the solar installation.
- If possible, position the energizer and solar panel(s) in the middle of the fence.
- Tilt the solar panel(s) to face the midday, winter sun.
- Adjust the solar panel(s) to face north in the southern hemisphere and south in the northern hemisphere.
- If possible, fasten the energizer to the underside of the solar panel.

Refer to a Tru-Test product brochure or the Tru-Test website www.tru-test.com for more information about solar installations.

Installing an earthing system

What is earthing?

An earthing system is the most important component of any electric fence system. If an electric fence is not properly earthed, it will be much less effective.

How does earthing work?

For an electric fence to be give an animal an electric shock, electrons must complete a circuit. Electrons travel from the energizer, along the wires, through the animal's body, through the soil to the earthing system, then back up to the energizer.

The earth system consists of a number of earth rods (earth stakes) that absorb electrons in the soil. The larger the energizer and the longer the fence line, the more earth rods are required.

What factors will affect the earth system?

Dry, sandy and non-conductive soil types allow electrons to spread out without being absorbed by the earth rods. If you have soil that is not well suited to earthing, use additional earth rods, choose a better location for the earth system or use an alternative method of earthing, such as a bentonite salt earth system.

Vegetation touching the live fence wires allows electrons to leak, causing the fence to 'short' and voltage to drop. Check the fence regularly to make sure that long grass and overhanging branches are not touching the live fence wires.

Using a mixture of metals in the earth system will lead to electrolysis. This may cause the parts of the earth system to disintegrate in a short period of time. For example, never use copper wire with galvanised earth rods.

All live system

An all live system is recommended where soil is conductive (most moist soils are conductive). When an animal standing on the soil touches the fence, the circuit is completed and the animal gets a shock.

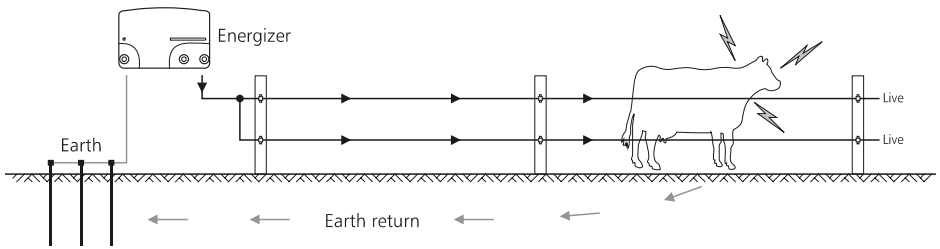

Earth wire return system

An earth wire return system is recommended where soil is not conductive (most dry or sandy soils are not conductive). The fence is constructed using both live and earth wires. When an animal touches a live and an earth wire at the same time, the circuit is completed and the animal gets a shock.

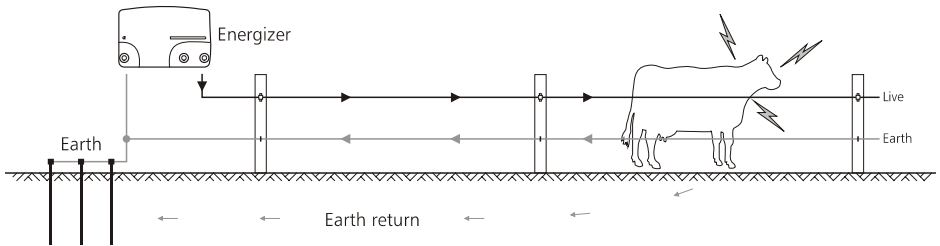

Bentonite salt earth system

A bentonite salt earth system is recommended for extremely dry soil conditions. A mixture of bentonite and salt surrounds each earth rod. The salt attracts moisture and acts as a conductor while the bentonite retains moisture over long periods of time. Stainless steel earth rods are required in order to prevent salt corrosion.

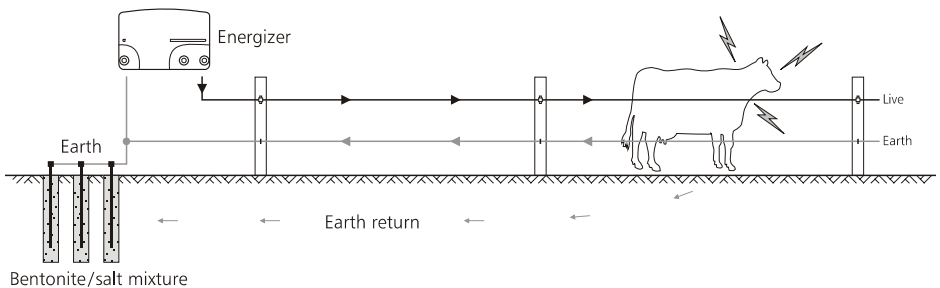

Selecting a site for the earth system

A suitable place for an earth system is:

- at least 10 m (33') away from any other earth system, for example, a telephone or house mains/line power earth system.
 - away from stock or other traffic that could interfere with the installation.
 - where the system can easily be accessed for maintenance.
 - ideally, where there is damp soil all year round (e.g. a shaded or swampy area).
-

Tip:

- If it is not possible to locate the earth system in close proximity to the energizer, you may be able to use the existing fence line to connect to a remote earth system.
 - In dry weather, it may be necessary to water the earth system in order to improve soil conductivity.
-

Earth rods

The number of earth rods required depends on the type of energizer being used to power the fence. Refer to information supplied with your energizer for more information about the correct number of earth rods to use.

To insert the earth rods:

- 1 Space the required number of 2 m (6'6") earth rods at least 3 m (10') apart. (If using a bentonite salt earth system, space the earth rods at least 10 m (33') apart.)
- 2 Drive 2 m (6'6") earth rods deeply into the soil, at least 3 m (10') apart. Make sure that the earth rods protrude out of the soil by 10 cm (3") so they can be easily connected.
- 3 Join the earth rods in a series using joint clamps and insulated cable.

Testing the earth system

To test the earth system:

- 1 Turn off the energizer.
- 2 At least 100 m (330') away from the energizer, heavily short circuit the fence by laying several steel rods (or lengths of pipe) against the fence. In dry or sandy soils, drive the rods up to 30 cm (12") into the soil.
- 3 Turn on the energizer.
- 4 Use a digital voltmeter to measure the fence voltage. It should read 2 kV or less. If not, put more steel rods against the fence.
- 5 To check the earth system, insert the voltmeter's earth probe into the soil at the full extent of the lead and attach the clip to the last earth rod. The voltmeter reading should be no more than 0.3 kV. If the reading is higher than this, the earth system is insufficient. See the earthing checklist, add more earth rods, or find a better location for your earth system.

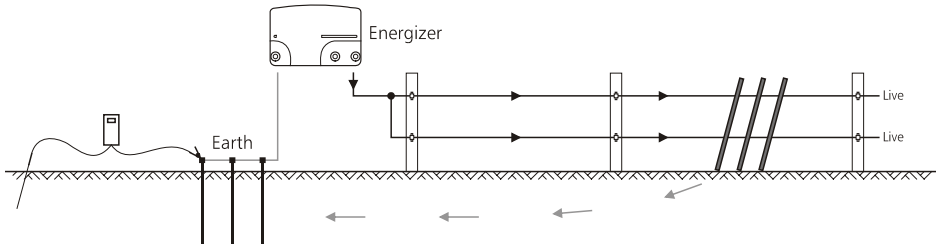

Earthing checklist

Check your earth system to make sure:

- all wires are joined securely
- connections to earth rods are secure
- earth rods are at least 3 m (10') apart
- earth rods are at least 2 m (6'6") long
- there are a sufficient number of earth rods
- all parts of the earth system are made of the same metal
- the earth rods are buried deeply in the soil.

Leadout from the energizer

A leadout cable or wire (a leadout) carries the electrical current from the energizer to the electric fence. It can be installed overhead or underground.

Resistance results in a voltage drop between the energizer and the fence. Ideally, a leadout should have as little resistance as possible.

Factors to consider before installing a leadout:

- a shorter leadout has less resistance
- a leadout with a large diameter has less resistance, allowing the electrical current to flow better.
- installing a leadout close to the soil increases the risk of voltage drop, due to leakage through vegetation.
- two leadouts connected in parallel will have much less resistance than a single leadout with a larger diameter.

Example: Where a long leadout is required for an energizer exceeding 10 J output, use two cables connected in parallel or a larger diameter 4.0 mm (8 gauge) wire.

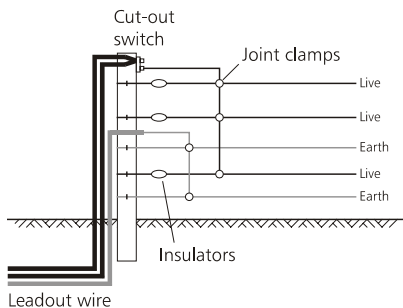

Here are some options for a leadout in order of preference:

- 1 Use a well-constructed 4-5 wire electric fence as a leadout.
- 2 Use offsets (stand-offs) or outriggers to attach a leadout to a conventional fence. Space them at 10-15 m (33-50') intervals and use 3.15 mm (10 gauge) wire at a height of 800 mm (2'6"), or less depending on vegetation.
- 3 As above, but use 2.5 mm (12 gauge) wire.
- 4 Electrify the top two wires of an existing fence, ensuring battens and posts are insulated.

Note:

- If you have an earth wire return system, make sure that the live leadout and the earth wire cannot touch each other.
 - Keep stray wires well away from the leadout.
 - Where a leadout may come into contact with another object, use insulators or insulated tubing.
-

The table below shows the DC resistance in ohms of a single galvanised steel fence wire over 1 km (¾ mile). The lower the resistance, the better.

Wire diameter	Wire resistance
4.0 mm (8 gauge)	14 ohms/km
3.15 mm (10 gauge)	22 ohms/km
2.5 mm (12 gauge)	35 ohms/km
1.6 mm (16 gauge)	90 ohms/km

Fence posts

Here are the options available for fence posts:

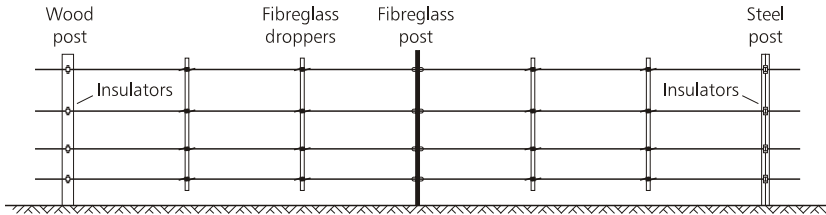

Wood posts

- strong
- rigid
- highly visible
- provide a psychological barrier
- easy to insulate

In soft ground, wood posts can be driven straight into the soil. In hard soil, a spike can be used to form a hole before the post is inserted.

Steel posts

- strong
- rigid
- provide a physical barrier
- easy to insulate
- ideal for broken hill country terrain.

Fibreglass posts

- lightweight
- flexible
- no maintenance
- no additional insulation required
- easy and fast to install
- low cost

You may also like to add droppers or battens to your fence. These have many benefits:

Droppers or battens

- these can be made of wood, plastic or fibreglass
- recommended for use with all types of fence post
- maintains wire spacing
- increases fence visibility

To attach a fibreglass dropper:

- 1 Strain the fence wire to the required tension.
- 2 Bend back the wire on the dropper clips to release the pressure.
- 3 Position the dropper clip to any point on the dropper.
- 4 Slip one wing of the dropper clip over the fence wire.
- 5 Lever the other wing under the fence wire with a screwdriver.

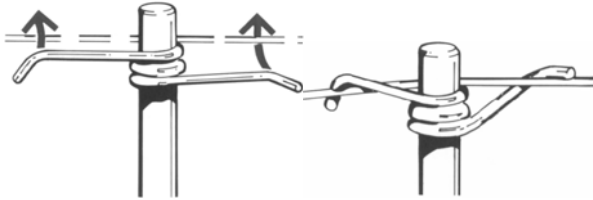

Droppers or battens should be inserted at right angles to a slope (not vertically) in order to maintain the height of the fence and the wire spacing.

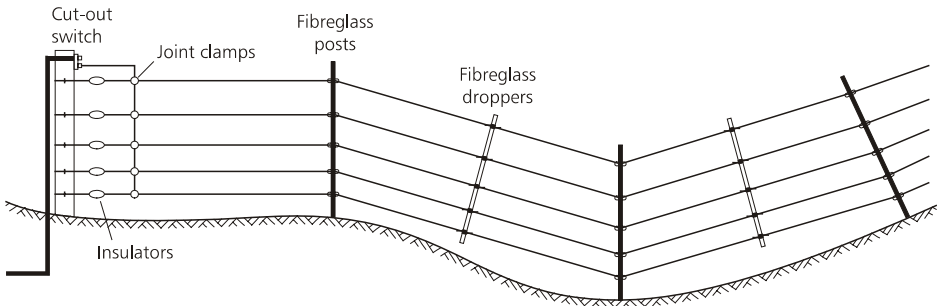

Strainer assemblies

Strainers are the foundations of a fence line. Strainers eliminate any fence movement and will keep the fence wires taut. A wood post 2.1 m (7') high, 150 mm (6") diameter is the most suitable strainer post for an electric fence.

There are several strainer assembly options. Make sure the option you choose can withstand the tension that will be applied to it.

Angle stay

Suitable for:

- strainer on a gate post
 - high tension straining
- 1 Install a foot at the base of the strainer, wired up to the post to prevent the post rotating when the wire is strained.
 - 2 Dig in a stay block just below ground level at a distance to ensure the angle stay will be held snugly in position.
 - 3 Lever the stay into position with a spade.

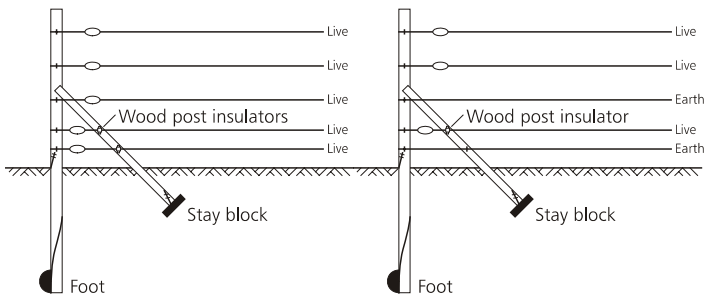

Bedlog

Suitable for

- firm soil
- low tension straining

- 1 Install a foot at the base of the strainer, wired up to the post to prevent the post rotating when the wire is strained.
- 2 Install a bedlog (breastplate) to ensure the strainer remains in position.

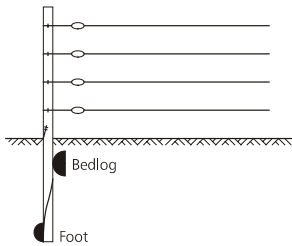

Horizontal stay

Suitable for:

- strainer on a gate post
- high tension straining
- areas with wet soil (strains above ground level)
- areas where heavy frosts occur
- controlling feral animals

A horizontal stay is simple to erect

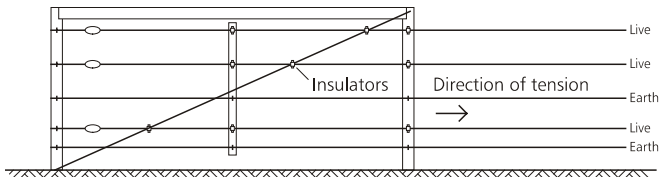

How much tension should be applied?

Electric fencing provides a psychological barrier rather than a physical one, so there is no need to excessively tension wire. Heavy strainer assemblies are not required either, reducing the overall cost of construction.

Electric fence wire should be tensioned to 90 kg (200 lb). Compare this to conventional fence wire which should be tensioned to 150 kg (330 lb). The tension of each wire can be measured using a tension meter.

Note: Increased tension may be required when controlling feral animals.

Wire

Hi-tensile wire should be used in preference to soft wire. Hi-tensile wire does not stretch or sag, and is therefore less likely to cause a fault.

2.5 mm (12 gauge) hi-tensile wire is ideal for permanent fences. Thinner gauges have greater resistance and are less effective.

Wire connecting the energizer to the fence has special requirements. See *Leadout cable or wire* on page 11.

Joining wire

Crimps are recommended for joining wires as they have good electrical contact and are almost as strong as the wire itself. Incorrectly joined wires can significantly reduce electric fence performance. For this reason, joining wire with knots is not recommended.

To crimp wires together:

- 1 Slide a crimp sleeve onto the end of the fencing wire until 6 mm ($\frac{1}{4}$ ") of wire is showing past the sleeve.
- 2 Push the wire to be joined through the opposite side of the crimp sleeve until 6 mm ($\frac{1}{4}$ ") of wire is showing past the sleeve.
- 3 Open the jaws of the crimping tool and place the jaws over the end of the crimp sleeve.
- 4 Ensure that the jaws overlap the end of the crimp sleeve slightly and that the crimping tool is at right-angles to the crimp sleeve. Compress the handles.
- 5 Slide the jaws of the crimping tool along the crimp sleeve without leaving 'shoulders' between crimps.

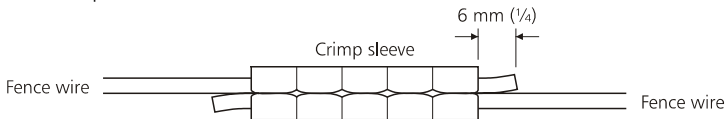

Barbed wire

Never electrify barbed wire. Why?

- Barbs may prevent a person or animal moving away from the electric fence which may result in injury or death.
- Barbs can tangle with other fence lines easily causing faults.
- Barbs can injure animals and cause damage to pelts.

Fence connections

Interconnect live wires at each end of the fence using joint clamps. Use high quality, double-insulated underground cable for connections to an earth system and beneath gates.

All live earth system

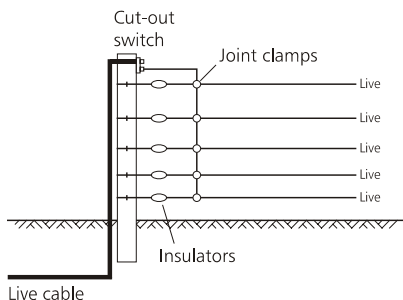

Earth wire return system

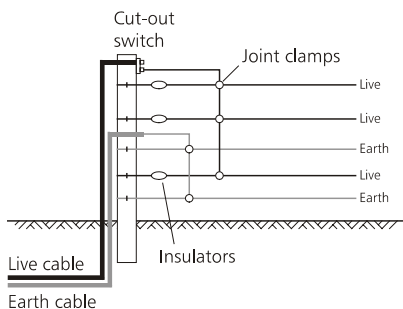

Gates

When by-passing a gateway it is essential to use high quality double-insulated underground cable encased in a high density polythene pipe. Bury the pipe at least 300 mm (12") deep. Turn the ends of the pipe down, well above ground level to keep water out.

Note:

- Ordinary non-insulated wire is liable to corrode over time when underground.
 - Low quality, thin cable can perish underground or may have insufficient insulation at high voltages. This will cause a drop in fence voltage or a complete short-circuit.
-

Conventional gate

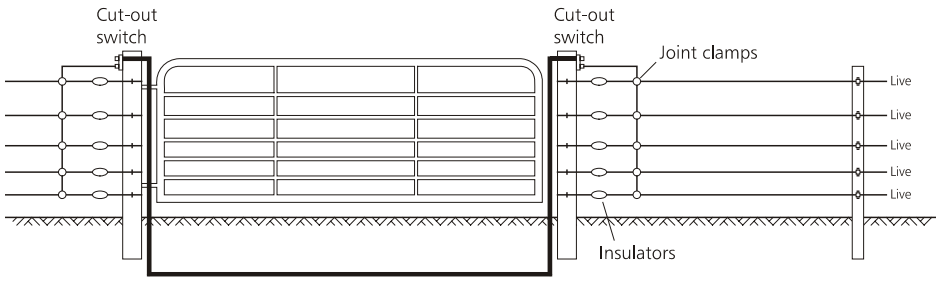

Spring (bungy) gate or tape gate

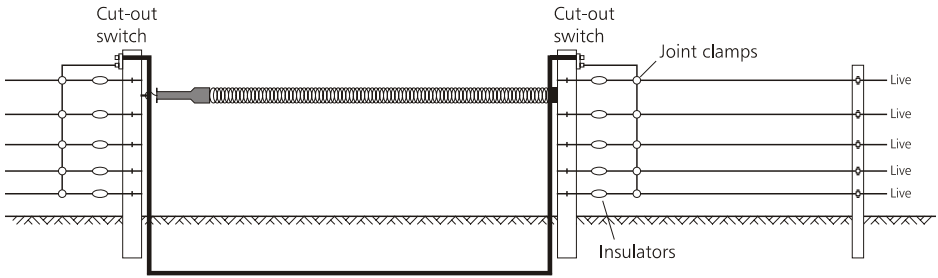

Earth wire return system gate

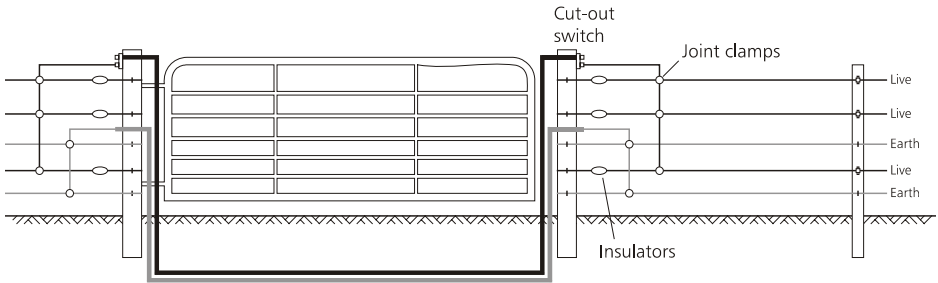

Lightning protection

Lightning will always find the quickest and easiest way to the earth. If this is through an unprotected electric fence, damage to the fence and energizer is likely.

In areas prone to severe lightning, a lightning diverter should be installed.

Lightning diverter

The lightning diverter has its own earthing system which must be installed at least 20 m (65') from the energizer's earth system. The lightning diverter's earth system must consist of more earth rods than the energizer's earth system.

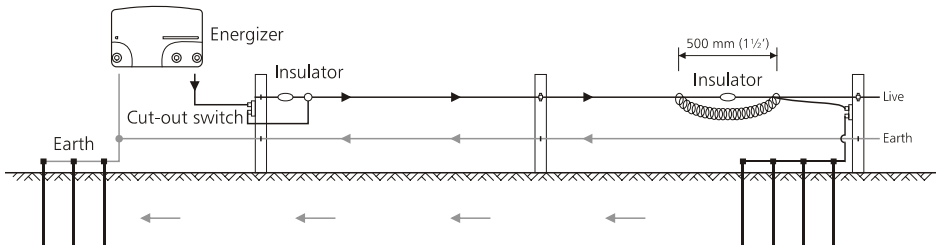

Additional ways to protect the fence and energizer

During an electrical storm, disconnect the energizer from the fence and earth system. Unplug a mains energizer.

If you have a mains/line energizer, install a voltage spike protector plug at the wall socket to protect the energizer from damage caused by surges of energy.

Note: No lightning protection can provide 100% protection, especially if the fence or energizer is subjected to a direct lightning strike.

Flood gates

An energy limiter can be used on a flood gate to prevent an entire fence from being shorted out during flooding. It limits the amount of power on the flood gate during a floods so that the remainder of the fence continues to have high voltage.

To construct a flood gate:

- 1 Drive two posts in on either side of the flood-way, above the highest flood level.
- 2 String a length of galvanized chain between the two posts with an insulator on either side.
- 3 Hang lengths of chain at 150-300 mm (6-12") intervals keeping ends approximately 200 mm (8") above average summer water level.
- 4 Connect an energy limiter from the fence to the flood gate.
- 5 Install a cut-out switch where water is likely to remain high for an extended period of time.

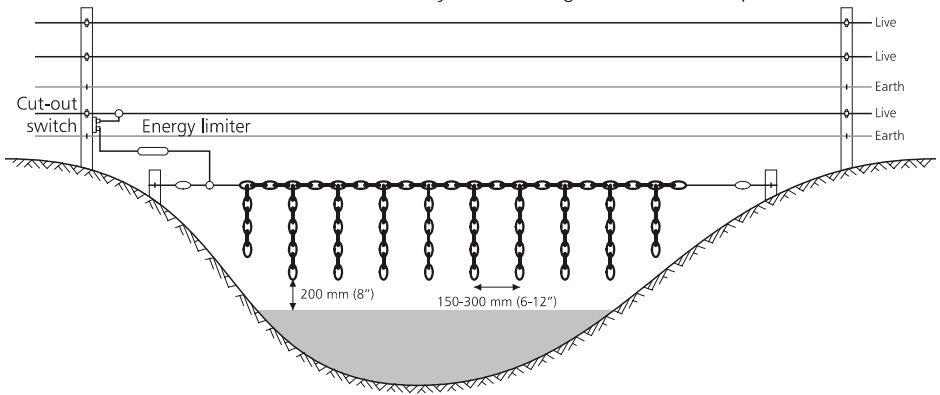

Electrifying a conventional fence

Older, non-electrified fences requiring replacement can be rejuvenated using insulated offsets (stand-offs) or outriggers and live wire. This will extend the life of the fence for many more years.

The life of a new conventional fence can also be extended this way. Having the fence partly electrified will reduce damage caused by animals leaning on the fence.

To add offsets (stand-offs) or outriggers to a fence:

- 1 Restore an old fence by removing some of the worst wires or by tightening them sufficiently so that they will not cause the live wire to short.
- 2 Interconnect existing fence wires and use as earth wires in an earth wire return earthing system. See *Installing an earthing system* on page 4.
- 3 Install live wire on one or both sides of the fence.

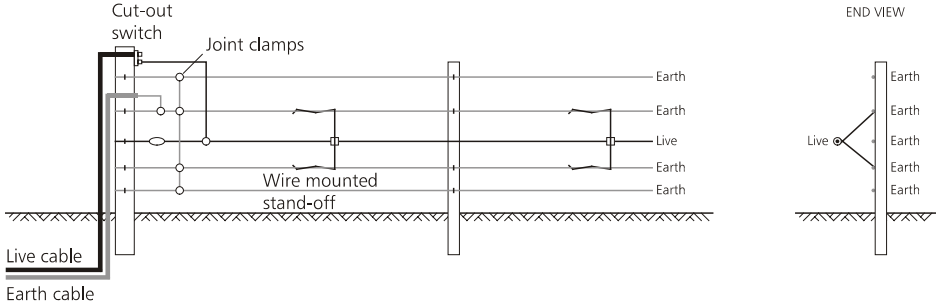

Subdividing the fence

Subdivision fences can be fed from the main fence. These fences should be kept relatively short to assist with possible fault finding later. Each connection should be made at one point only and should be fitted with a cut-out switch.

Temporary fence

Temporary fencing gives you the versatility to strip graze, make temporary paddocks or pens and to protect trees and gardens from damage by stock and feral animals.

Strip grazing for controlled rotational grazing is an excellent method of achieving maximum pasture utilization. For best early regrowth of pasture, back-fencing of areas already grazed is recommended.

Generally, temporary fences are moved daily. The distance moved depends on the number of animals being grazed and the quality and quantity of pasture available.

Animals that are being fenced temporarily will require a portable water supply within the fenced area.

Post and wire spacings

Here are some suggested post and wire spacings.

Most of the fences below can have an All live or Earth wire return system of earthing. See *Installing an earthing system* on page 7.

Dairy Cattle

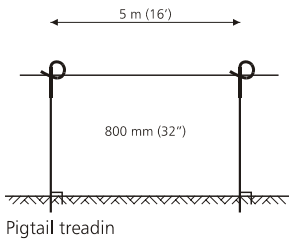

Cattle

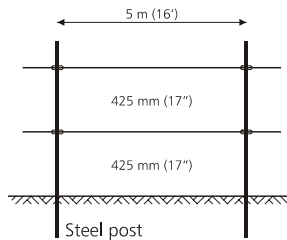

Sheep

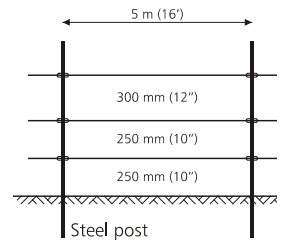

Choosing an energizer

How will you power your electric fence?

Battery A low powered battery energizer is ideal for powering temporary fences.

Solar Self-contained solar energizers have a built-in solar panel. These energizers are ideal for strip-grazing, or powering fences in isolated areas.

Comparing energizers

When evaluating energizers, be sure to compare them on the same basis.

Output energy the amount of energy that is delivered to the fence.

Stored energy the amount of energy stored inside the energizer. This does not necessarily relate to the amount of energy that is delivered to the fence.

It is best to compare energizers by looking at the output energy.

How much fence can the energizer power?

Approximately 1 joule of output energy will power approximately 10 km (6 miles) of fence wire. This will depend on the type of fence, the number of wires, climatic conditions, amount of vegetation surrounding the fence etc.

Using more than one energizer

Sometimes, dividing the fence-line up into separate sections and using one energizer for each fence-line may be preferable to connecting all the fence lines to one energizer. This gives more options for animal control and gives greater flexibility in farm management.

Warning! There should never be more than one energizer connected to the same fence line.

Installing an energizer

Before installing the energizer make sure you have read all the instructions provided with your energizer.

Battery powered energizer

- Mount out of reach of children and animals.
- If necessary, build a protective box or fence around the energizer.
- If possible, position the energizer in the middle of the fence

Self-contained solar powered energizer

- Mount out of reach of children and animals.
- If necessary, build a protective fence around the energizer.
- If possible, position the energizer in the middle of the fence.
- Tilt the solar panel face the midday sun in winter.
- Adjust the solar panel to face south in the northern hemisphere and north in the southern hemisphere.

Refer to a Tru-Test product brochure or the Tru-Test website www.tru-test.com for more information about solar installations.

Strip grazing installations

Here are some suggested configurations for strip grazing:

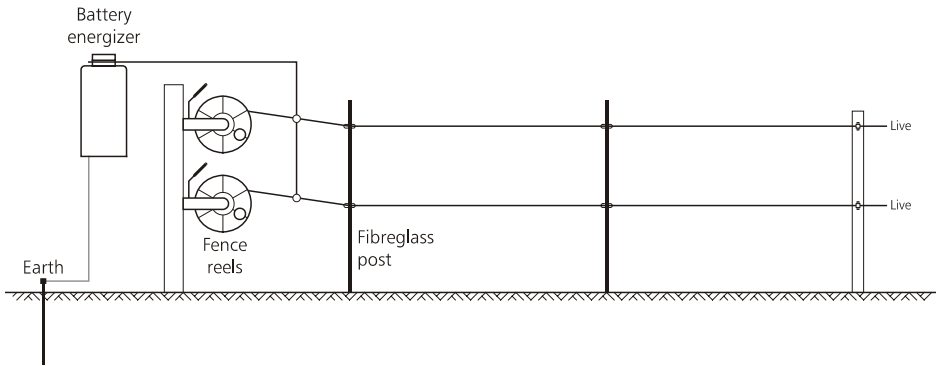
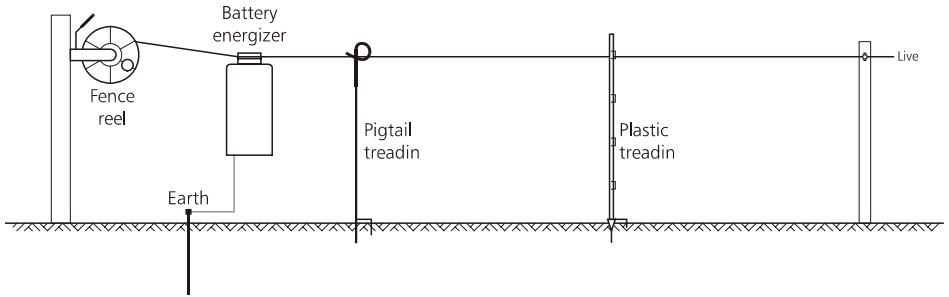

Fault finding

Faults (shorts) in the fence can reduce its effectiveness and may also cause other problems, such as interference on telephone lines or internet connections.

Causes for faults may include:

- Vegetation touching the live wires
- Broken wires or insulators
- Poor earthing
- Corroded metals somewhere in the fence-line
- Poor connections
- Poor insulation

Checking your fence regularly using a digital fault finder or a digital voltmeter is important in order to maintain an effective, problem-free electric fence installation.

Finding faults using a digital fault finder or digital voltmeter

Electrical current flows towards a fault (short) in the same way that water flows towards the plug-hole in a bath. A digital fault finder allows you to follow the direction of the current towards the fault, whereas a digital voltmeter allows you to test sections of the fence and isolate a faulty section.

Digital fault finder

To find a fault using a digital fault finder:

- 1 Check the energizer and the earth system.
- 2 Starting at the leadout, work your way along the fence taking readings at regular intervals. Always check around gateways, branches in the fence and wire joins, as faults are likely in these areas. A fault will show up as an abnormally high reading. A sudden reduction in current between one point and the next indicates a fault between the two points.

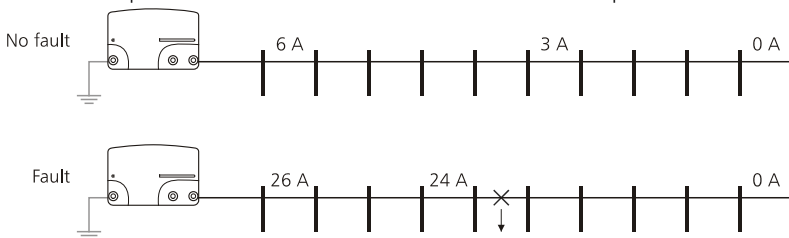

- 3 Move backwards in the direction of the lowest reading to locate the fault.

Digital voltmeter

Tip: When using a digital voltmeter to find faults, isolate sections of fence-line with cut-out switches.

To find a fault using a digital voltmeter:

- 1 Check the energizer and the earth system.
- 2 At the first cut-out switch (at the end of the leadout), disconnect the rest of the fence and take a voltage reading. The voltage should be normal.
- 3 Move along the fence-line disconnecting a section of the fence and taking a voltage reading at each cut-out switch. A fault will show up as an abnormally high reading.
- 4 If you are still having trouble, follow the Troubleshooting flowchart below.

Troubleshooting flow chart

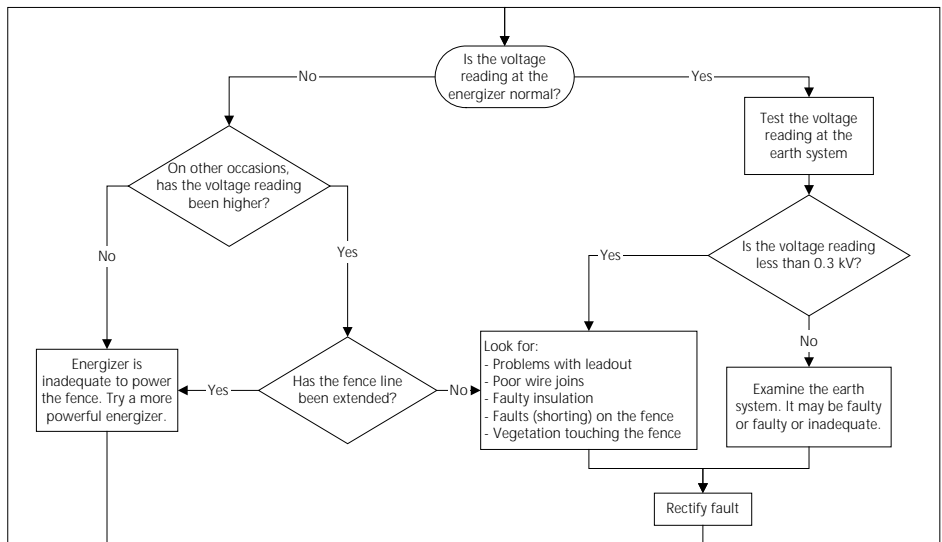

Telecommunications interference

Sometimes, an electric fence can cause problems with a telephone line or an internet connection.

Symptoms may include:

- Clicking noises on the phone line
- A slow or unreliable internet connection.

Faults can sometimes be hard to find because the problem fence can be anywhere between the telephone exchange and the phone line or internet connection with the symptoms. The fence owner may not suffer interference problems themselves, but neighbours might, even if they live several kilometers or miles away.

To resolve telecommunications interference problems, first check your own fence using the checklist below. If your fence proves to be OK, contact your neighbours and ask them to switch off their fences one at a time in order to isolate which fence is faulty. Check the faulty fence using the following checklist:

Checklist:

Find out where there are telecommunication cables or phone lines near your electric fence.

This includes buried and overhead wires and cables. Mostly, these run along or near the roadside reserve or along driveways. For assistance in locating telecommunication cables or phone lines, contact your nearest telecommunications company.

Identify potentially problematic electric fence wires and connecting leads.

Any electric fence wires and connecting leads within 100 m (330') of the phone lines or telecommunication cables can be potentially problematic, particularly if they are running parallel (or nearly parallel) to each other. Long sections of fence wire that feed other sections are more likely to cause problems than short sections that go nowhere else.

Check the current in these wires.

Use a fault finder to check measure the current in these fence wires. A good fence will measure no more than 2 amps per km (3 amps per mile) of energized fence line. If the reading is higher than this, there may be a short on the fence, there may be too much overgrowth, live wires could be contacting the ground, or insulators may have deteriorated.

If, after fixing faults, the current is still too high, find a way to feed the main power supply through sections of the fence that are further away from the phone line.

For example, feed the power out through fences in the middle of the farm, away from the phone line, rather than through a roadside boundary fence next to phone lines.

Check that the earthing system meets the requirements specified in your energizer's user manual.

All parts of the earthing system should be at least 10 m (33') away from buildings and other earthing systems. The earthing system should not be near a telephone line.

A good electric fence setup

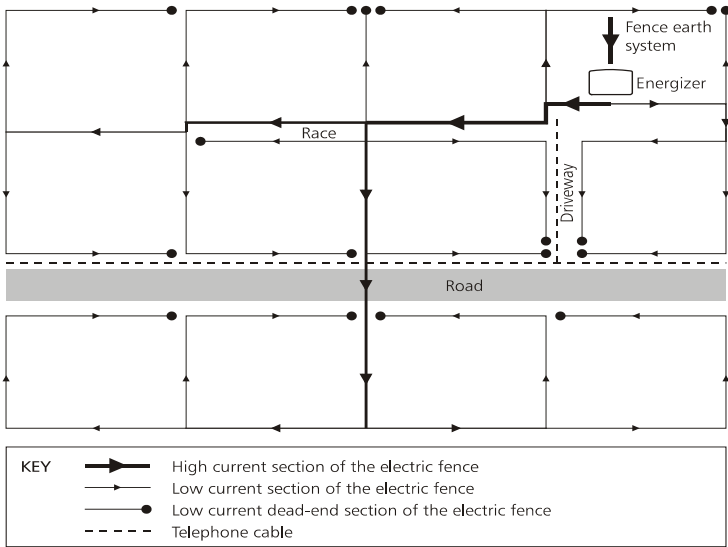

The ideal way to set up your electric fence is to feed the power out from the energizer in a 'star' fashion, with no closed loops and low currents in parts of the fence that closely parallel phone lines.

A poor electric fence setup

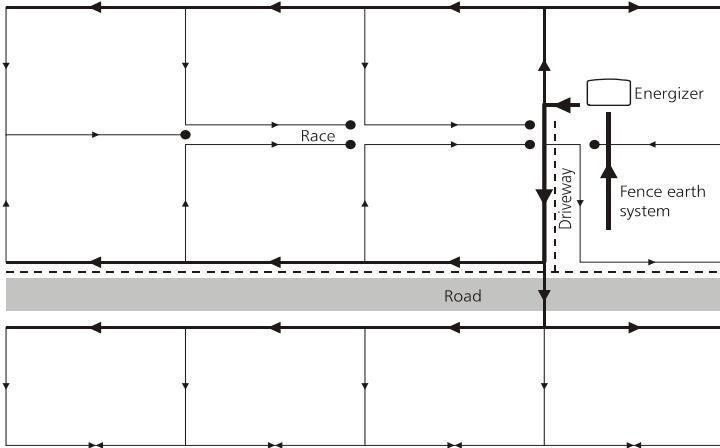

Tip: When buying a new computer modem, talk to the retailer about getting a product suited for use in a rural location.



Contact Details

Please see our website for contact details of your local distributor.

www.speedrite.com

