

**LEARNING
RESOURCE**

**AN EASY
GUIDE TO
UNDERSTAND
SCAFFOLD
TERMINOLOGY**

Relating to Basic, Intermediate
& Advanced Scaffolding

ACCESS
SCAFFOLDING



...here to help TM

We Deliver
to site, on time

We Erect
to your requirements

We Dismantle
with minimum of fuss

We Pick Up
from site

We offer...

Free quotes

On-site inspections

Full Public Liability

Insurance

Australian Made Product

Licensed Scaffolders

State Plant Registrations

FREE QUOTES ON ALL YOUR SCAFFOLDING NEEDS

- INDUSTRIAL, COMMERCIAL & DOMESTIC SCAFFOLDING
- STAIR TOWER SCAFFOLDS
- LADDER ACCESS TOWER SCAFFOLDS
- BIRDCAGE SCAFFOLDS
- VOID FILLS
- CANTILEVERED SCAFFOLDS
- STEEL KWIKSTAGE
- BRIDGING UNITS
- MOBILE SCAFFOLDS
- COMPLETE HOUSE WRAPS
- TUBE & COUPLER SCAFFOLDS
- COMPLIANT WITH AS/NZS4576 & AS15761-6
- FULLY INSURED
- FULL ERECT AND DISMANTLE SERVICE
- TICKETED & EXPERIENCED SCAFFOLDERS
- FRIENDLY SERVICE

This publication is created in conjunction with Access Scaffolding and The Scaffold Tool & Training Company

© Access Scaffolding & The Scaffold Tool and Training Company
Issued: 2016

This publication may not be reproduced or utilised in any form (electronic or mechanical including printing, photocopying or recording) without permission from The Scaffold Tool & Training Company

All information is correct at time of printing. The Scaffold Tool & Training Company reserves the right to modify specifications Product specification, technical descriptions and other information provided in this booklet are given as guidance only.

ACCESS SCAFFOLDING



HEAD OFFICE
62-64 Garnsworthy Street
Springvale North
Victoria 3171
P: 1300 551 610

DANDENONG OFFICE
1 Hillside Street
Springvale North
Victoria 3171
(03) 9547 6682

GEELONG OFFICE
48 Denbigh Street
Moolap
Victoria 3224
(03) 5248 8087

ADELAIDE OFFICE
Factory 5, 55 Norfolk Street
Marion
South Australia 5043
0425 898 966



MAS15-0084

accessscaffolds.com.au

THE PROFESSIONALS IN SCAFFOLDING: Hire | Sales | Tools | Training | Manufacturing | Repairs

Different Scaffold Types



BIRDCAGE SCAFFOLD

A birdcage scaffold is an independent scaffold that consists of more than two rows of standards in both directions and is connected by ledgers and transoms. It is mainly used for work that is to be carried out on a single level, such as ceilings or large stages.



TOWER SCAFFOLD

A tower scaffold is an independent scaffold consisting of a single bay built vertically, it can be: ladder access tower, stair access tower, mobile tower or static tower.

INDEPENDENT SCAFFOLD

An independent scaffold consists of a double row of standards, with each row parallel to the building. The inner row is set as close to the building as is practicable and no further than 225mm away if there are not handrails.



Variety of Scaffold Systems

Scaffolds are commonly used in construction work so workers have a safe, stable work platform when work cannot be performed at ground level or on a floor or stable base.

Frame scaffold ~ A modular scaffold assembled from prefabricated welded frames, braces and accessories such as Access Scaffolding 440 Series. Basic level scaffolding.

Mobile scaffold ~ An independent free-standing tower scaffold that is mounted on castors wheels for ease of relocation. Basic level scaffolding.

Modular scaffold ~ A scaffold assembled from prefabricated individual components, braces and accessories. A modular scaffold is a system where you can not alter the use of the components and it must be assembled according to the manufacturers specifications. Basic level scaffolding.

Brands of modular scaffold include:

- ◆ Access Aluminum
- ◆ Atpac
- ◆ Cuplock
- ◆ Kwikstage
- ◆ Leyher
- ◆ Monzon

Non-powered Suspended Scaffold ~ Any scaffold platform that is hanging from a supporting structure. It may be fully fabricated from steel or aluminium, or constructed from scaffold tubes, couplers and planks. Advanced level scaffolding.

Powered Suspended scaffold ~ A scaffold incorporating a suspended platform which can be raised and lowered, including a boatswain's chair, swingstage and work cage. They can have a climber type hoist or a reeling type hoist. Advanced level scaffolding.

Prefabricated scaffold ~ A modular scaffold assembled from prefabricated components and erected to comply with erection guidelines. Erection guidelines must be provided by the manufacturer and/or the supplier (the same as a frame type scaffold). Basic level scaffolding.

Single pole scaffold ~ A scaffold consisting of a single row of standards that are connected together by ledgers and putlogs fixed to ledgers and built into the wall of a building or structure. Also known as a brickies scaffold or a putlog scaffold.

Tower scaffold ~ A scaffold of one bay erected in the form of a tower.

Tube and coupler scaffolding ~ A scaffold of which the standards, ledgers, braces and ties are scaffold tubes that are joined together by couplers. This is intermediate level scaffolding.

Individual Components

Individual components that make up a Frame Type Modular Scaffolds
The maximum height of a mobile scaffold is 9 meters

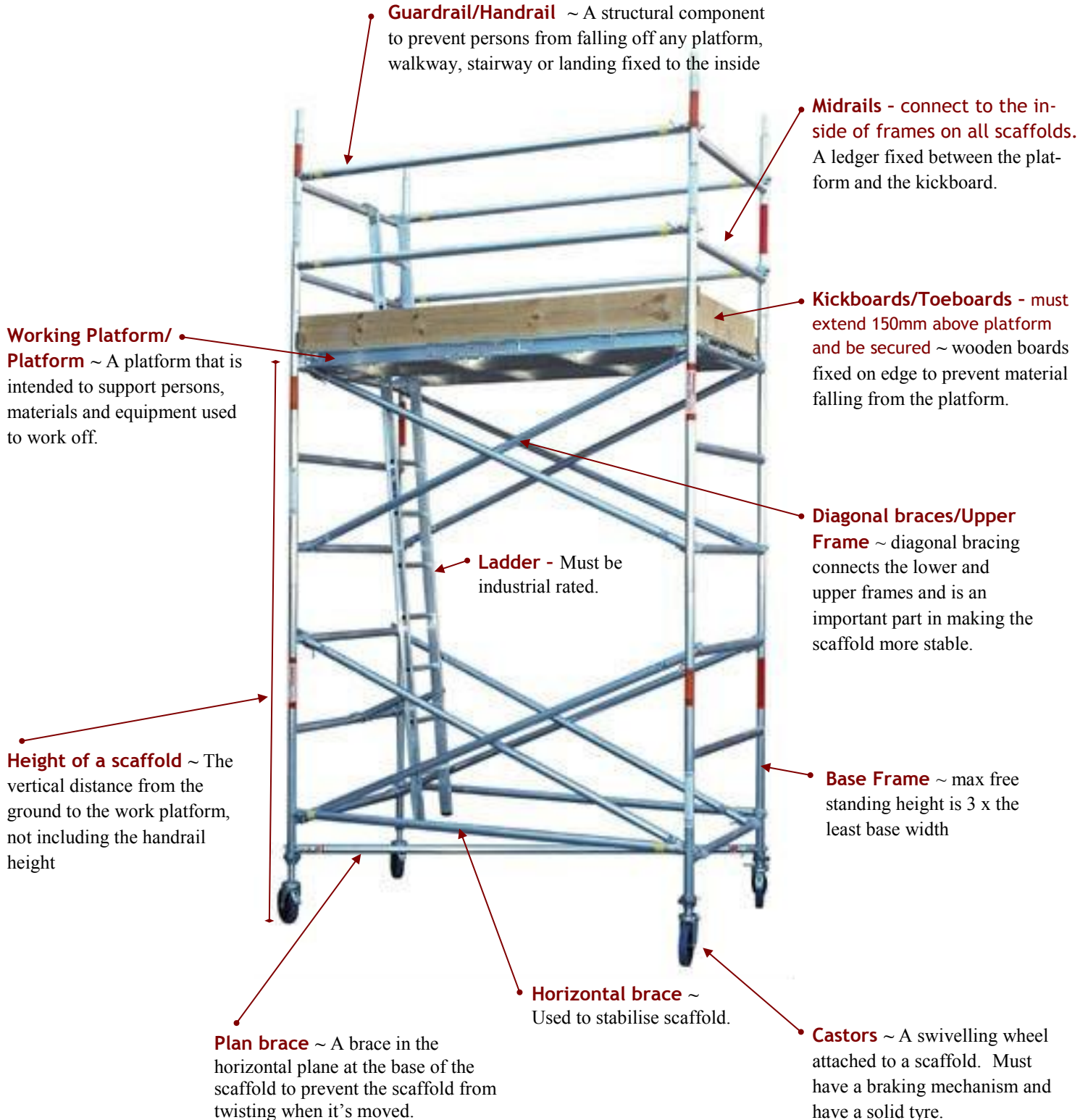

A

A

Access platform ~ A platform with a hatch or trap door in it for personnel access.

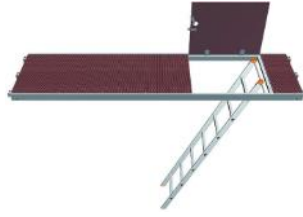

Adjustable baseplate ~ A baseplate with an adjustable spindle. Also known as *screwjack*, has a maximum vertical load of 3030kg.



Adjustable castor ~ A castor incorporating a height-adjusting device that fits inside the standard or vertical component of a scaffold.



Advanced scaffolder ~ A person who performs:

- a) the work of a basic and intermediate scaffolder; and b) scaffolding work associated with: hung scaffolds, including scaffolds hanging from tubes, wire ropes and chains; or powered suspended scaffolds.



Anchor bolt ~ The type of approved anchor to secure a wall or anchor tie. Also known as a *boa coil*



Articulated cradle ~ A cradle of joined sections hinged together enabling workers to walk from one section to another.



B

Back splice ~ A splice in the end of a fibre rope to prevent it from unlaying. Also known as an *end splice* or a *dog stick*.



Bald eye ~ An eye in a rope which is not protected by a thimble. Also known as *soft eye*.



Barrow hoist ~ Modular transportable lifting device used to handle light loads. Also known as *materials only hoist*. Basic Scaffolders can only install up to 500kg SWL.



Barrow ramp ~ Scaffold designed with a sloping ramp with cleats to prevent slipping. Used to push a wheelbarrow up and down on.



Baseplate ~ See *Couplers* (Pg 9)

Bay ~ The space enclosed by four adjacent standards, or the equivalent space in a single-pole scaffold.

Bay length ~ Distance between any two standards on the long side of the bay (longitudinal spacing).

Bay width ~ Distance between any two standards on the ends of the scaffold (transverse spacing).

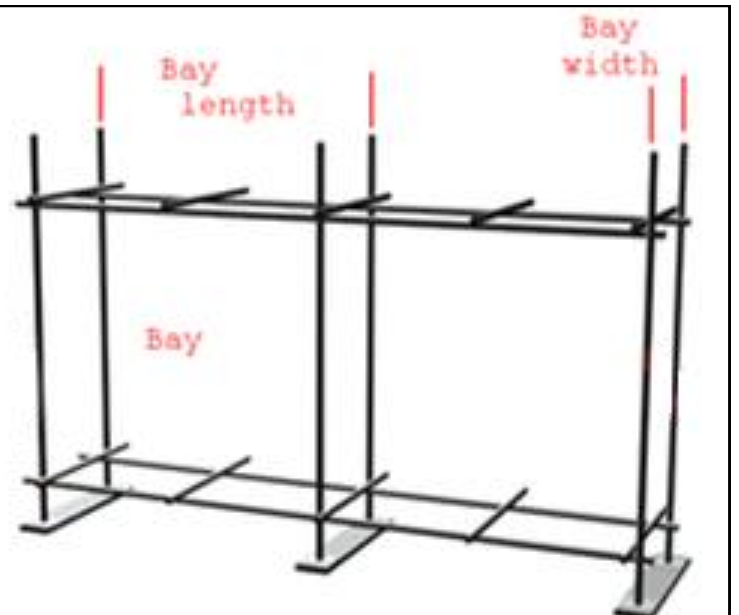

Basic scaffolder ~ A person who performs scaffolding work associated with:

- a) prefabricated modular scaffolds over 4 meters
- b) cantilevered materials hoist with a maximum working load of 500kg
- c) ropes
- d) gin wheels
- e) safety nets and static lines
- f) bracket scaffolds including 2 plank walkways.



Beam chaffer ~ A short length of material, sometimes half round, used to protect from the sharp edge of a beam when using ropes slings or chains.



Beam clamp ~ See *Couplers (Pg 9)*.

Birdcage scaffold ~ An independent scaffold consisting of more than two rows of standards connected by ledgers and transoms.

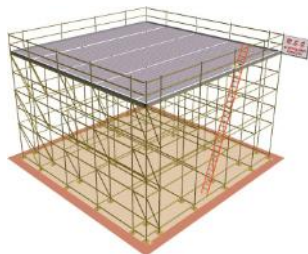

Boatswain's chair ~ A suspended scaffold of which the platform is a chair or similar device, suitable for use by one person

Board retainer ~ See *Couplers (Pg 9)*.

Boards ~ Also known as *captive plank*. See *Scaffold plank/board*

Box tie ~ A tie assembly of tubes and couplers that is fixed to a column or beam in the shape of a box.



Brace ~ A component fixed diagonally to scaffold standard, to provide rigidity to the scaffold. See *Diagonal Brace*

Bracket scaffold ~ A scaffold that has a platform carried on brackets. Also known as *two plank system*.



Brick guard ~ A meshed panel secured between a guardrail and platform, and incorporating a kickboard. Also known as *mesh panel*.



Bricklayer's scaffold ~ See *Single-pole scaffold*.

Building Maintenance Unit (BMU) ~ Prefabricated swinging stage permanently fixed to a building



Butt ~ A tube fixed to a scaffold and butting to an adjacent structure to prevent horizontal movement of the scaffold.

Butterfly coupler ~ A style of putlog coupler. See *Couplers (Pg 9)*

Buttress bay ~ A bay of scaffold used to extend the base size to increase the freestanding height.

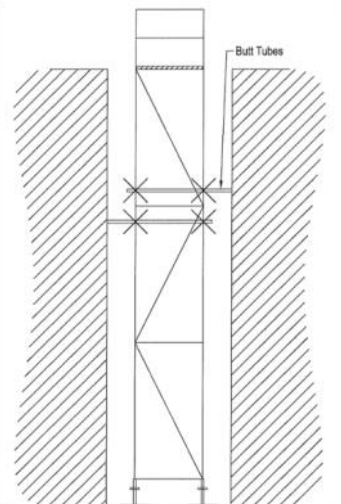

C

Castor ~ A swivelling wheel attached to a scaffold. See *Individual Components (Pg 5)*



Catch fan ~ A cantilevered platform or structure attached to a scaffold to contain falling debris and provide protection below the scaffolding. Also known as *catch platform*.



Check coupler ~ An additional coupler fixed for strength or safety. See *Couplers (Pg 9)*

Climber hoist ~ A scaffolding hoist that climbs the suspended flexible steel wire rope.



Column tie ~ Similar to a box tie but with only one tie tube. See *Box Tie*

Competent person ~ A person suitably qualified, adequately trained and appropriately experienced for the particular class or kind of work described.



Containment sheeting ~ Screening attached to a scaffold to prevent the dislodgement of tools and materials from a working platform or to protect the people using the scaffold from the elements.



Counterweight ~ A weight or series of weights that counter-balance a scaffold against overturning.



Coupler ~ Also known as *fittings* or *joiners*. See *Couplers (Pg 9)*.

Cradle ~ The platform of a suspended scaffold. Also known as *'the boat'*.



Cross braces ~ generally used in a frame type prefabricated system. See *Diagonal brace*.

Cantilever ~ A steel beam or similar which is anchored at one end and is cantilevered out of the building at the other end.

Cantilevered builders' hoist ~ A builder's hoist where the platform travels up and down on the outside face of a building.

Cantilevered crane loading platform ~ A temporary loading bay cantilevered from the face of a building or structure to land or lift crane handled loads.



Cantilevered platform materials hoist ~ A powered builder's hoist which has the lift platform cantilevered from the hoist tower. It moves materials only, up and down the face of a building or structure. Also known as *'barrow hoist'*.

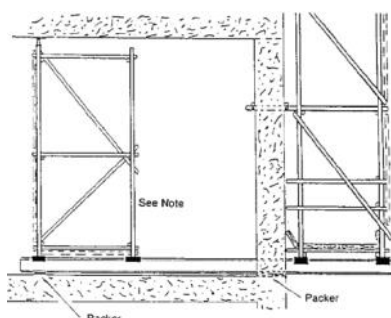

Cantilevered scaffold ~ A scaffold that is supported by cantilevered load-bearing components.

Couplers, Joiners & Fittings

All fittings must be marked with the manufacturer's or supplier's name or trademark and a code traceable to a manufacturing batch in accordance with Australian Standards AS1576.2-2009.

Baseplate ~ A metal plate that is able to distribute the load from a standard to a supporting structure, min size 150 x 150 x 6mm



Beam clamp ~ A fitting that is able to secure a scaffold tube to a steel I beam. They must be used in pairs. Also known as a *girder clip/gravelock*.



Board retainer ~ Used to retain wooden kick boards. Also known as *toeboard retainer*.



Butterfly coupler ~ double flap putlog coupler



Check coupler ~ A right-angle coupler or swivel coupler that is fixed hard against a load-bearing coupler, to restrict or prevent slippage of that coupler along the tube. Also known as a *safety coupler* or *keeper clip*.



Coupler ~ A fitting that joins two tubes. Also known as *fittings* or *joiners*.



Double C clip ~ for joining standards side-by-side (back to back). Also known as *Gantry Coupler*



External joiner ~ A coupler used to join two tubes end-to-end that fit over the outside of the tubes (must have a separation plate between tubes). Also known as an *end-to-end coupler* or *sleeve coupler*.



Hook ~ Can be used as a putlog coupler or to retain wooden kickboards or the ladder. Also known as *mills hook* or *mickey hook*.



Internal joiner ~ An internal *end-to-end coupler* for joining two tubes. Also known as a *joint pin*. NOT TO BE USED TO JOIN LEDGERS ON TUBE SCAFFOLDS



Ladder clamp ~ A fitting incorporating a bolt and a nut used to secure a ladder to a scaffold tube.



Ninety-degree coupler (90°) ~ A non-swivel load bearing coupler, for connecting two tubes at right-angle. Also known as *90's*, *doubles* or *right angle coupler (RAC)*



Parallel coupler ~ A coupler for making a lap or spliced joint between two tubes.



Putlog blade ~ A fitting fixed to the end of a putlog, so that the putlog may be located and supported in a wall



Single coupler ~ A coupler for fixing a putlog to a ledger. Also known as a *single putlog coupler*, *pigs ears* or *pork chops*.



Swivel coupler ~ A coupler for connecting two tubes at any angle.



Toeboard clip ~ For steel boards, clamps to the standard with a wedge to hold the toe board vertically. Also known as a *wine glass clip*.



D

Dead load ~ The part weight of the scaffold components on a particular standard.

Debris net ~ A fine mesh net usually laid over an industrial safety net in order to catch small light items of falling debris.



Diagonal braces ~ Fitted to the scaffold frames, these play an important part in making the structure more stable. *See Individual Components (Pg 5)*



Dog leg brace ~ *See Transverse brace*

Double C clip ~ *See Couplers (Pg 9)*

Double coupler ~ Also known as **ninety-degree coupler**. *See Couplers (Pg 9)*

Double rope suspension system ~ A method of suspending a cradle using two hoists and two suspension ropes at each support point (cannot be counterweighted).

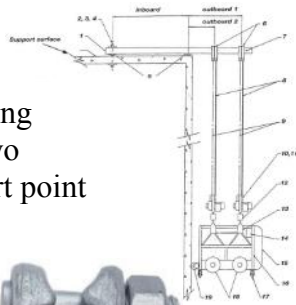

Double saddle clamp ~ Also known as **fist grip/wire rope grip**

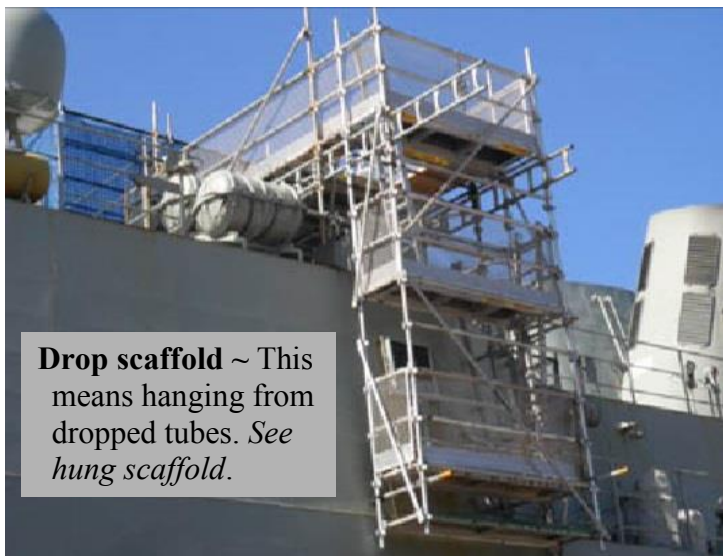

Drop scaffold ~ This means hanging from dropped tubes. *See hung scaffold.*

Dropper ~ *See hung scaffold.*

Dual coverage ~ Work which can be performed by someone who holds either the appropriate class of rigging certificate or the appropriate class of scaffolding certificate, because the work is within the scope of both types of certificate. Eg: swing stage installation.



Dyna bolt ~ A sleeve type anchor which is **NOT** to be used to secure a scaffold wall anchor or tie.



Dynamic load ~ The forces on the scaffold caused by persons moving on the scaffold or mobilising or moving a scaffold.

E

Edge protection ~ A barrier or system to prevent a fall from heights and must be on all scaffolds where a person or object can fall more than 2 meters.



Egress ~ Exit an area or work platform (opposite to access).



End-to-end coupler ~ A coupler for joining two tubes end-to-end. Also known as **internal joiner** and **external joiner**. *See Couplers (Pg 9)*

Environmental load ~ the load caused by environmental factors such as debris or snow



Erection ~ to assemble a scaffold

External joiner ~ *See Couplers (Pg 9)*

Eye bolt ~ A component that attaches to a structure with an eye to enable something to be secured, such as a safety net. Must be collared bolts.



F

Fabricated hung scaffold ~

A pre-assembled scaffold hung from another structure but which is not capable of being raised or lowered when in use. It is sometimes used for large steel erection projects.



Face brace ~ See Longitudinal brace

False standard ~ See Puncheon

Falsework ~ Any temporary structure used to support a permanent structure while the permanent structure is not self supporting.



Fan ~ See Catch fan

Fibre rope ~ A natural fibre rope such as manila.



Fixed cradle ~ A cradle that does not traverse horizontally, but is capable of being raised and lowered.



Forkhead ~ See U-head jack

Foundations ~ The support beneath a scaffold or structure that distributes the loads (ground)

Image is an example of bad practice



Frame scaffold ~ A scaffold assembled from prefabricated frames, braces and accessories. See Variety of Scaffold Systems (Pg 4)

Frame trestle scaffold ~ A scaffold, other than a trestle ladder, consisting of self supporting stands that support scaffold planks.



Freestanding scaffold ~

A scaffold that is not attached to any other structure and is stable against overturning, on its own account or if necessary assisted by stabilizers, outriggers, counterweights or backup bays (buttress bay).



Fulcrum point ~

The point of balance on a cantilevered needle.



G

Gantry ~

A structure, constructed from structural steel, scaffolding or structural timber, that is primarily intended to support a protection deck or portable buildings such as amenity sheds.



Gantry coupler ~ Also known as *Double C clip*. See *Couplers (Pg 9)*

Girder clip ~ Also known as *Beam clamp*. See *Couplers (Pg 9)*



Girder trolley ~ An assembly that locks over a steel flange but can be rolled along the flange



Gin wheel ~ A wheel hung from a scaffold that a rope runs through to raise and lower materials.

Guardrail ~ A component to prevent persons from falling off any platform, walkway, stairway or landing. See *Individual Components (Pg 5)*

H

H Frame ~ A prefabricated frame in the shape of an 'H'



Hand balling ~ Passing equipment from one level of a scaffold to another.



Hand over certificate ~ A certificate certifying a scaffold is safe and giving its individual specifications.



Handrail ~ A rail to provide a handhold on a platform or stairway. It may form part of a guardrail. See *Individual Components (Pg 5)*

Heavy duty working platform ~ A scaffold platform with a duty live load capacity of 675 kg per bay. This is three times the capacity of a light duty platform.

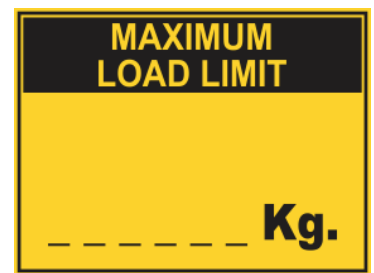

Height ~ The distance a person can fall from a scaffold.

Height of a scaffold ~ The vertical distance from the ground to the work platform, not including the handrail height. See *Individual Components (Pg 5)*

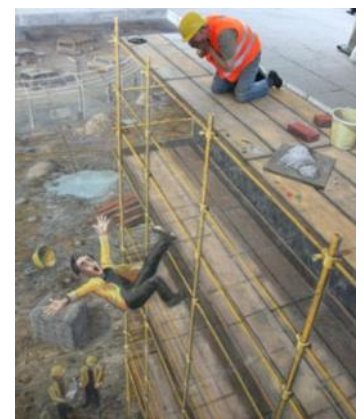

Hoardings ~ Panels used to partition areas like walkways and perimeter fences (used to contain and protect)

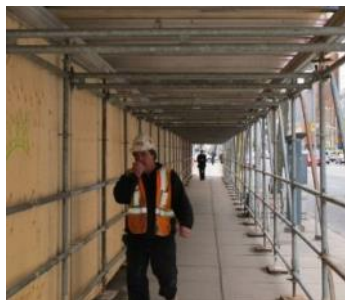

Hoist/s ~ An appliance or machine used to raise or lower a load with no horizontal movement designed to lift materials and personnel.

Hoisting ~ Raising or lowering a load.



Hook ~ See Couplers (Pg 9)

Hop-up bracket ~ See Platform bracket

Horizontal Brace ~ See Individual Components (Pg 5)

Hung scaffold ~ An independent scaffold that is hung from another structure but is not capable of being raised or lowered when in use. Also known as a **dropper** or **slung scaffold**



Inboard ~ That portion of the suspension rig or needle which is on the inside of the fulcrum point (inside the building).

Inside diameter (ID) ~ The distance across the inside of a circular object, tube, pipe or similar (40mm NB). Also known as **nominal bore**

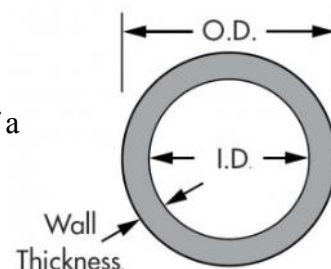

Internal joiner ~ Also known as **joint pin**. See Couplers (Pg 9)

Independent scaffold ~ A scaffold with at least two rows of ledgers and does not use a building or structure to support the working platform.

Individual cradle ~ A cradle of one bay length.



Intermediate scaffolder ~

A person who performs:

- a) the work of a basic scaffolder;
- b) scaffolding work associated with: cantilevered crane loading platforms; cantilevered and spurred scaffolds; barrow ramps and sloping platforms; perimeter safety screens and shutters; mast climbers; and tube and coupler scaffolds, including tube and coupler covered ways and gantries.



Internal perimeter scaffold

~ A scaffold erected alongside the inside perimeter of a penetration or shaft in a building or other structure.



J

Joiner ~ A coupler for joining two tubes end-to-end.
See external joiner and internal joiners

Joint pin ~ *See internal joiner*

K

Keeper clip ~ Also known as *check* or *safety coupler*.
See Couplers (Pg 9).

Key ~ *See Scaffold spanner*

Kickboard ~ Also known as a *toeboard*. This prevents tool and equipment from being kicked off the scaffold.
See Individual Components (Pg 5)

Kwikstage (Kwikform) ~ One of the most commonly used scaffolding systems in Australia. Kwikstage is a heavy duty wedge type modular system.



L



Ladder ~

All ladders used to access scaffold must be single, industrial grade ladders and pitched at a ratio of between 1:4 and 1:6 horizontal to vertical



Ladder access tower ~ An independent scaffold bay attached to a scaffold with internal ladder access provided.

Ladder access putlog ~ *See Ladder access transom*

Ladder access transom ~ A modular component used to support shorter scaffold planks to allow a penetration for the ladder.



Ladder beam ~

A scaffold beam with chord stiffeners at right angles to the chords (a beam in the basic shape as a ladder on its side).



Ladder bracket ~ A bracket scaffold consisting of two or more ladders that support planks by means of brackets, to provide a working platform.



Ladder clamp ~
See Couplers (Pg 9).

Landing ~ A level area providing access to a stairway or ladder, or located at an intermediate level in a system of stairways or ladders.

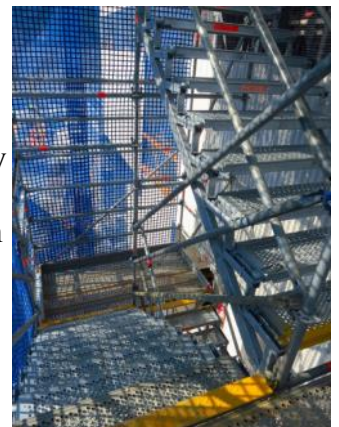

Ledger ~ A horizontal structural component that longitudinally spans a scaffold.

Lift ~ The first row of ledgers and transoms attached to the scaffold at the lowest possible connection point on the standard. Also the vertical distance between ledgers. **NB: The maximum distance between lifts is 2.0m.**

Light duty working platform ~ A platform on a scaffold with a duty live load capacity of 225kg per bay.



Live load ~ Weight of persons and materials on the scaffold.

Loading bay ~ A platform on a scaffold for the storage of materials and equipment.



Load-limiting device ~ A device that limits the lifting capacity of a scaffold hoist to a specific load below the stalling load of the motor (set at 1.25 x the SWL of the hoist)



Longitudinal brace ~ A brace on the long side of the bay. Also known as a *face brace*.



M

Machine spliced eye ~ Splice which used some form of ferrule or end stop, which is then swaged onto the rope. Both turnback and Flemish eye splices are mechanical splices.



Mast climbing work platform ~ A work platform used for temporary purposes to raise personnel and materials to a working position by means such as a rack and pinion drive mounted on an extendible mast, which may be tied to a building.



Materials (only) hoist ~ A builder's hoist used for raising and lowering materials (not personnel) including a cantilevered platform materials hoist. Also known as a *barrow hoist*.



Maximum rope tension ~ The maximum force which can be imposed on the suspension rig including the safe working load on the platform, the self-weight of the platform and the suspension ropes and the hoist weight.



Medium duty working platform ~

A platform on a scaffold with a duty live load capacity of 450 kg per bay. This is twice the capacity of a light duty platform.



Member ~ Also known as **components**. See *Individual Components (Pg 5)*

Mesh panels ~ See *Brick guard*.



Mesh screening ~ used on a scaffold to prevent dislodgement of plant and materials and to protect workers from environmental conditions.

Midrail ~ A ledger fixed between the platform and the kickboard. See *Individual Components (Pg 5)*

Mills hook ~ Also known as a **micky hook**. See *Couplers (Pg 9)*

Mobile scaffold ~ An independent free-standing scaffold that is mounted on castors (max free standing height is 9 meters). See *Variety of Scaffold Systems (Pg 4)*.

Modular scaffold ~ A scaffold assembled from prefabricated individual components, braces and accessories. See *Variety of Scaffold Systems (Pg 4)*. Made by various manufacturers under various trade names, such as:

- Aluminum frame type
- Atpc
- Cuplock
- Kwikstage
- Leyher
- Monzon

N

Needle ~ A cantilevered structural steel I beam that forms part of the scaffold assembly. Cantilevered out board = 1/4 of total length.



Ninety-degree coupler (90°) ~ Also known as **doubles** or **right angle couplers**. See *Couplers (Pg 9)*

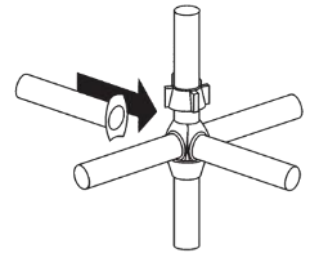

Node point ~ The connection point on a Kwikstage standard. Also known as the **stars** or **crossing point**.

Nominal bore (NB) ~ See *Inside diameter (ID)*

O

Outboard portion of the suspension rig ~ That portion of the suspension rig which is on the outside of the fulcrum point (or balance point).

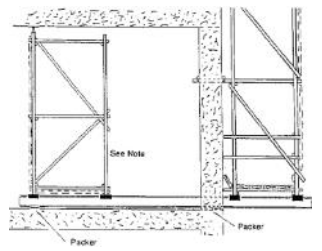

Outrigger ~ A brace used to increase the base size of the scaffold to allow an increase in the freestanding height.



Outside diameter (OD) ~ The distance across the outside of a circular object.

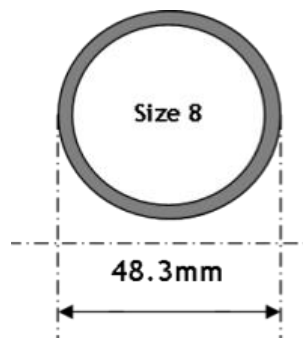

Open turn buckle ~ A turnbuckle used to tension a static line and is open for visual inspection.

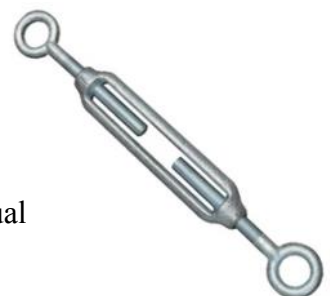

P

Parallel coupler ~ See *Couplers (Pg 9)*.

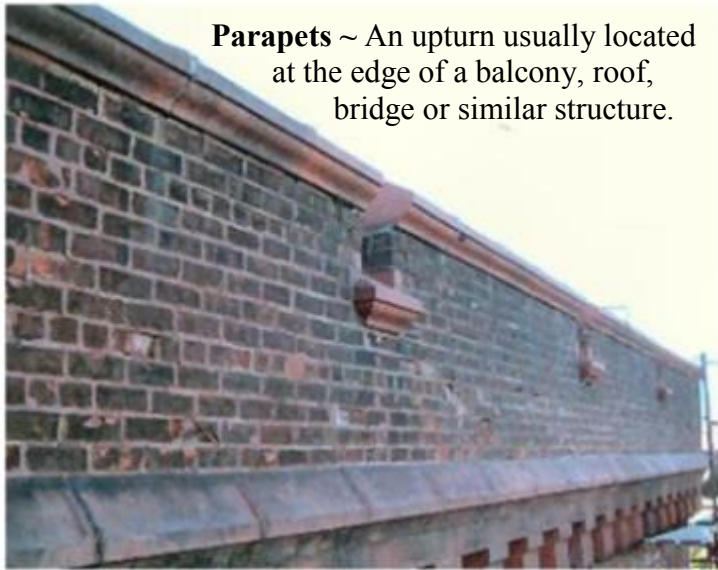

Parapets ~ An upturn usually located at the edge of a balcony, roof, bridge or similar structure.

Perimeter scaffold ~ A scaffold erected alongside the external face of building or other structure. Also known as a *wrap*.



Personnel hoist ~ A mechanical hoist designed to carry people.



Pintle ~ A projection at the top of a castor that is used to locate the vertical component of a mobile scaffold (150mm min stem).

Plan brace ~ A brace in the horizontal plane at the base of the scaffold to prevent the scaffold from twisting when it's moved. See *Individual Components (Pg 5)*

Plank ~ A component used to form a working platform or deck. See *Scaffold Plank/Board*



Platform ~ An elevated working surface. See *Individual Components (Pg 5)*

Platform bracket ~ A bracket attached to a scaffold that enables a platform to be placed between the scaffold and a building or structure. Also known as a *hop-up* bracket.



Podger hammer ~ A cast steel hammer used for the erection and dismantling of scaffold.



Prefabricated scaffold ~ A scaffold assembled from prefabricated components and erected to comply with erection guidelines. Erection guidelines must be provided by the manufacturer and/or the supplier. See *Variety of Scaffold Systems (Pg 4)*



Protective device ~ A device which will arrest the descent and support a cradle or boatswain's chair in the event of the failure of the suspension rope or the scaffolding hoist. NOTE: A protective device may also prevent an over speed descent.



Puncheon ~ A standard that does not touch the ground and is supported from another structural component of the scaffold. Also known as a *false standard*

Putlog ~ A horizontal structural component, spanning between ledgers or between a ledger and an adjacent wall, that is intended to support a platform.

Putlog blade ~ See *Couplers (Pg 9)*

Putlog coupler ~ Also known as *single coupler* See *Couplers (Pg 9)*

Putlog scaffold ~ See *Single pole scaffold.*

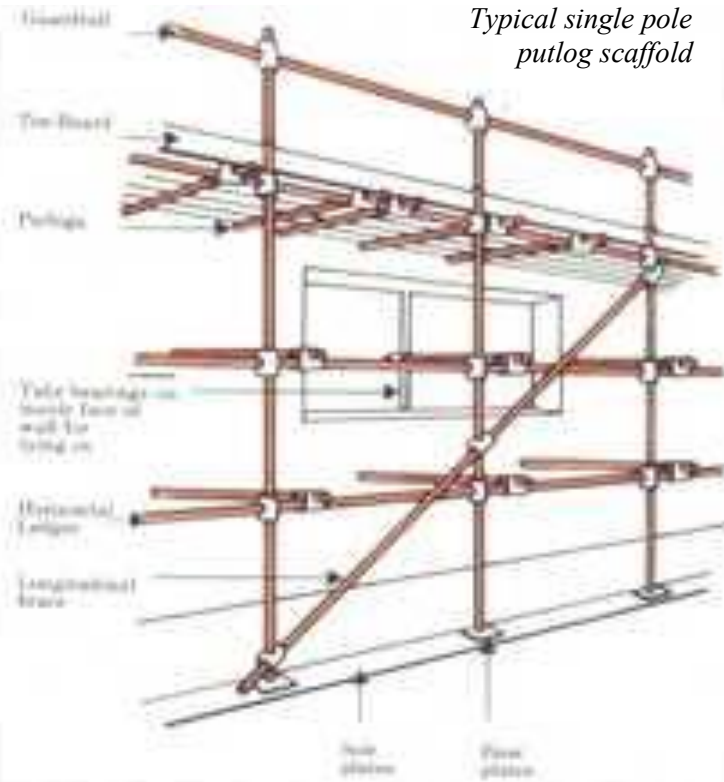

Typical single pole putlog scaffold

R

Raker tie ~ A scaffold tube attached to the scaffold at one end and to a building or structure at the other at obtuse angles.

Reeling hoist ~ A scaffolding hoist where the FSWR reels around the hoist drum.



Return ~ A part of a scaffold set up around the corner of a building or structure



Return transom ~ A transom used in modular scaffolding that is able to fix a scaffold return at right angles to a run, by being secured to a ledger.

Reveal ~ Internal side surfaces of an opening or recess

Reveal tie ~ A tie assembly consisting of a scaffold tube and two screw jacks wedged between an opening. Also known as a *friction tie*.



Rigging basic ~ Rigging work involving any of the following:

- structural steel erection
- hoists
- pre cast concrete components of a structure
- safety nets and static lines
- mast climbing work platforms
- perimeter safety screens and shutters, and
- cantilevered crane loading platforms.

Right-angle coupler ~ Also known as *ninety-degree coupler (90°)*. See *Couplers (Pg 9)*.

Roof edge protection ~ A barrier or system to prevent workers falling from the roof.



S

Safe Working Load (SWL) ~ The maximum load which may be applied to a crane, hoist, rope, chain or sling or scaffold.

Safety harness ~ Fall arrest device for arresting a fall, consisting of harness, lanyard, shock absorber and scaffold hook.



Safety rope ~ See *Secondary rope*.

Scaffold ~ A temporary structure for supporting access platforms or working platform. See also definitions for *birdcage scaffold*, *boatswain's chair*, *cantilever scaffold*, *freestanding scaffold*, *mobile scaffold*, *putlog scaffold*, *single-pole scaffold* and *tower scaffold*.

Scaffold duty ~ The safe working load of the scaffold. Eg: Live loads permitted on a scaffold bay (light, medium, heavy or special) people, plant and materials.

Scaffold key ~ See *Scaffold spanner*.

Scaffold plank/board ~ A decking component, other than a prefabricated plank, that is able to be used in the construction of a platform and is supported by the transoms or putlogs for metal or timber.



Scaffold spanner ~ A box or tube-type wrench with a swing-over handle that has been purpose designed for the tightening and loosening of coupler nuts.



Scaffolder ~ A person engaged in erecting, altering or dismantling scaffolding.

Scaffolding equipment ~ Any component, assembly or machine used or intended to be used or the construction of scaffolding



Scaffolding hoist ~ A lifting appliance manually operated or power-operated through which the suspension rope passes.



Screw jack ~ See *Adjustable base plate*

Secondary safety rope ~

Rope not carrying the weight of a cradle and the imposed load, but rigged for use with a fall arrest device.

Shackle ~ A load rated component with a removable pin which is a portable link in a chain. Also known as a **D shackle** or **bow shackle**



Shoring jack ~ See *U-head Jack*

Shutter-bracket scaffold ~ A bracket scaffold where the brackets are attached to formwork shutters.



Single coupler ~ See *Couplers (Pg 9)*. Also known as **single putlog coupler**

Single pole scaffold ~

A scaffold consisting of a single row of standards that are connected together by ledgers and putlogs fixed to ledgers and built into the wall of a building or structure. See *Variety of Scaffold Systems (Pg 4)*

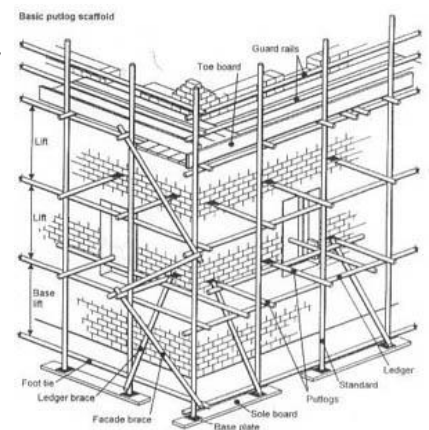

Single rope suspension system ~ A method of suspending a cradle using one hoist and a single suspension rope at each support point.



Sleeve coupler ~ Also known as an *external joiner* or *end-to-end coupler*. See *Couplers* (Pg 9).



Sling ~ A lifting device (e.g. web sling, chains, wire ropes and ropes).

Slung scaffold ~ See *Hung scaffold*.



Soleboards/Soleplate ~ A length of timber used to distribute the combined live load and dead load through a baseplate to the ground or other supporting structure.



Sloping platform ~ Platforms formed when scaffolding is erected at an angle. Maximum slope for a working platform is 3°. Barrow ramps can have a slope of up to 20°.



Span ~ The distance measured between the putlog of a working platform depending upon the thickness of the planks.

Spur ~ An inclined load-bearing component that transmits a load to a supporting structure.

Spurred scaffold ~ A scaffold that is partially supported by inclined load-bearing components.

Stability ~ Security of a scaffold against movement and overturning.

Stair unit ~ A modular scaffold tower incorporating stringer or treads for safe access and egress.

Stanchion ~ A scaffold tube hand rail post.

Standard ~ A vertical structural component that transmits a load to the supporting structure.

Static load ~ The weight of a single heavy item on the work platform.

Stile ~ The side of a ladder that supports the rungs, steps or treads.

Stillage ~ A scaffold basket or framework designed to hold scaffolding components



Stop (through bolted) ~ The stop at the end of a rail or track to prevent the trolley rolling of the end.



Stop end ~ Guardrails fitted to a scaffold between standards at the end of a bay.



Stringer ~ A stair unit used to support stair treads.

Stud bracket scaffold ~

A bracket scaffold of which the brackets are attached to studs of a timber frame building or other structure. *Also known as two plank system.*

Supporting structure ~ A structure, structural components or foundation that supports a scaffold.



Suspended scaffold (powered) ~

A scaffold incorporating a suspended platform which can be raised and lowered in normal use, including a boatswain's chair.



Suspension gear ~ The assembly which joins the cradle to the suspension rig.

Suspension mounted hoist (reeling hoist) ~ A scaffolding hoist that is mounted on a suspension rig or trolley track, with one end of the rope attached to the cradle and the other end to a hoist drum.



Suspension point ~

That point where the suspension rope is connected to the suspension rig (where the max rope tension is).



Suspension rig ~ The portion of a suspended scaffold (including a trolley track) which is mounted at a higher level than the cradle and which supports and positions the cradle. Also known as a *roof rig*.



Suspension ropes ~

Ropes carrying the weight of the cradle and the imposed load.



Swing stage ~ A suspended scaffold with a single row of suspension ropes.



Swivel coupler ~ See Couplers (Pg 9).

SWL ~ The safe working load or the duty load limit of the scaffold.
 Light duty = 225kg SWL
 Medium duty = 450kg SWL
 Heavy Duty = 675kg SWL



T

Tank-bracket scaffold ~ A bracket scaffold of which the brackets are able to be attached to the face of a metal tank, duct, boiler, structural beam or similar. The planks lie on top of the brackets and are lashed in place.

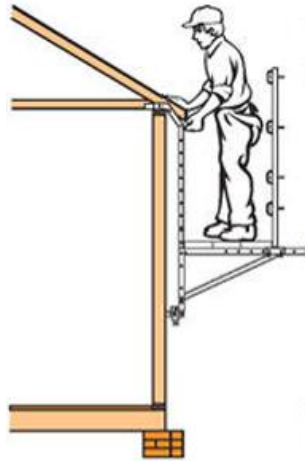

Three times rule ~ The maximum height you may free stand a scaffold = "3 x the least base width".
Eg 1.2 x 3 = 3.6mtr to the platform

Through tie ~ A tie assembly that is positively fixed to both sides of an opening through a building or structure.



Thimbled eye ~ is used to create a reinforced eye at the end of a wire rope. Also known as *hard eyes* they allow the eye to hold its shape under load, and is used to protect the wire rope from damage by usage and attached hardware.

Tie ~ An assembly of tubes and couplers used to tie a scaffold to a supporting structure.

Tie bar ~ Used to tie hop up brackets together to prevent the brackets from spreading and the planks from becoming dislodged.



Toeboards ~ Also known as *kickboards*. A scaffold plank or purpose-designed component fixed on edge at the edge of a platform, to prevent material falling from the platform (minimum height 150mm). See *Individual Components (Pg 5)*

Toeboard clip ~ See *Couplers (Pg 9)*

Toeboard retainer ~ Also known as *board retainer*
See *Couplers (Pg 9)*

Tower scaffold ~ A scaffold of one bay erected in the form of a tower. See *Variety of Scaffold Systems (Pg 4)*

Tower-frame scaffold ~ A single bay of prefabricated scaffold erected in the form of a tower which is a single bay built vertically.

Trainee ~ A person who enrolled in a High Risk Work course or is being supervised by a HRW Licence holder at work.

Transom ~ A horizontal structural component transversely spanning an independent scaffold between the standards. Transoms transfer the live load from the platform down through the standards.



Transverse brace ~ A brace in the end of the scaffold.

Trap door ~ A hatch or opening platform

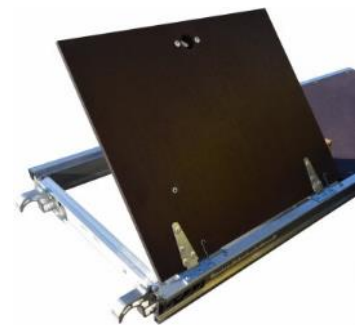

Travelling cradle (traversing cradle) ~ A cradle capable of being moved horizontally on trolleys.

Traversing ~ Moving laterally across the face of the building.

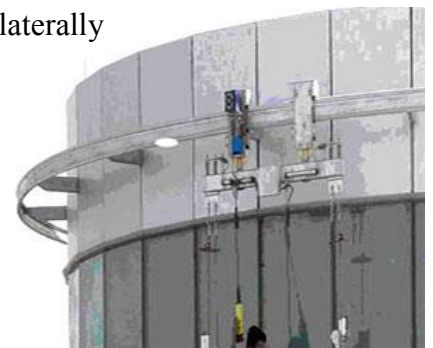

Traversing ropes ~ Ropes rigged for the purpose of traversing the cradle, but not carrying the weight of it.

Traversing suspension rig ~ A suspension rig mounted on wheels or castors and supporting a cradle.

Trestle scaffold ~ A scaffold consisting of trestles and planks.



Trolley ~ A wheeled mechanism intended to support a hoist which is capable of travelling along a suspended track.

Trolley track ~ The suspended rail which supports and guides trolleys in traversing installations.

Tube and coupler covered way ~ An independent tube-and-coupler scaffold that is primarily intended to provide overhead protection.

Tube and coupler scaffolding ~ A scaffold of which the standards, ledgers, braces and ties are scaffold tubes that are joined together by scaffolding couplers. *See Variety of Scaffold Systems (Pg 4)*



Tubes ~ The term used for steel or aluminium scaffold tube extrusion.

U

U-head jack ~ used for supporting and locating a standard over a needle. Also known as *forkhead* or *shoring jack*.

Uniformly Distributed Load (UDL) ~ A load distributed evenly along the length of a platform.



V

'V' pressing ~ *See Node point*

W

Webbing slings ~ A sling made from synthetic webbing and tagged with a safe working load.



Wedge socket ~ is useful when the fitting needs to be replaced frequently. The arrangement is knocked in place, and load gradually eased onto the rope. As the load increases on the wire rope, the wedge become more secure, gripping the rope tighter.



Whipping ~ The wrapping or tying of an end of cut rope to stop fraying or unravelling



Wind load ~ The force on the scaffold caused by the wind.



Wire rope grips ~ Bull dog clips (not to be used in scaffolding)

Work cage ~ A suspended scaffold cradle supported by a single suspension rope. Usually designed for one person.



Working load limit ~ The maximum working load that may be applied to any component or system, under general conditions of use.



Working platform ~ A platform that is intended to support persons, materials and equipment. Refer light, medium and heavy duty working platforms. *See Individual Components (Pg 5)*



1300 133 922

www.accesscaffolds.com.au

enquiries@accesscaffolding.com.au

Dandenong | 3/5 Berends Drive, Dandenong

Geelong | 48 Denbigh Street, Moolap

Adelaide | 5/55 Norfolk Street, Marion

07-00-17

ACCESS
SCAFFOLDING



...here to help TM